

The Midea logo is displayed in white on a blue rectangular background in the top right corner. It features a stylized 'M' inside a circle followed by the word 'Midea' in a sans-serif font.

As High As 7 Star
Energy Rating



7 year
warranty



Midea EOS

Keep Cool with More Ease



Midea, established in 1968 is a public company listed and since July 2016 a Fortune 500 company offering one of the most comprehensive ranges in the home appliances industry. Midea specializes in air treatment (residential and commercial solutions), refrigeration, laundry, cooking appliances, small kitchen appliances, water appliances, floor care and lighting.

Simply ideal

(ideal product & ideal life)

Since 1968, Midea has been making homes more comfortable, efficient, and inspiring standing alongside millions of families around the world.

For over half a century, we have been part of everyday life, witnessing moments of joy, connection, and care in every corner of the home.

From pioneering smart technologies to creating

solutions that balance quality, innovation, and value, Midea has continuously redefined what the “ideal” home can be.

Our purpose has always been simple: to be by your side, making each day just right, and turning your home into a place where life feels simply ideal.

MD Appliances Pty Ltd

Founded in 2018, MD Appliances Pty Ltd is the official Australian distributor of Midea’s air conditioning solutions for residential and commercial markets. Its mission is to deliver world-class cooling technology, energy efficiency, and superior comfort across Australia.

The company’s vision is to become a leading HVAC company in the country, built on a professional team that combines experienced sales with agile operations and

after-sales support. With a long-term, efficiency-driven strategy and a culture of innovation, execution, and collaboration, MD Appliances has grown steadily since day one.

From deep on-site learning and capturing government energy rebates, to expanding contractor networks, opening brand stores, and scaling internal teams, MD Appliances has evolved into a mature and growing force in the Australian HVAC industry.

more than
\$67.19B USD
of revenue in
2025

serve
customers in
200+
countries

40
global
production
centers

190K+
employees
worldwide

global Fortune
246
company



7 years parts and labor warranty

For Hi-Wall/ Ducted/ Cassette/ VRF / Heat pump



5 years parts and labor warranty

For Window Box A/C



2 years parts and labor warranty

For Heavy Commercial Products



Local after sales service and support



Healthy Air Management

I - CLEAN

Midea Inverter AC undergoes a 6-step cleaning process for the IDU evaporator and ODU condenser, followed by high temperature steam sterilization at 56°C for over 30 minutes. Keeping the AC clean and performing well.

99.99%* Sterilization



Staphylococcus aureus



E. Coli



H1N1



EV71



Total

62* mins

10min



1 Water start to condensate, get ready for deep wash

10min



2 Condensated water gets frosting, removing dirt adhered to the evaporator

3min

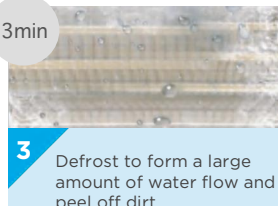

3 Defrost to form a large amount of water flow and peel off dirt

7min



4 High temperature cleaning via steam, removing moisture and dust

≥30 min

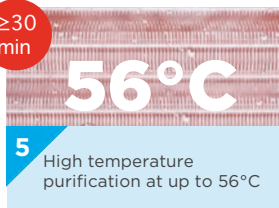

5 High temperature purification at up to 56°C

2min



6 Fresh air supply

How to enter “i-clean” mode through remote controller?

Press “SET” → Choose “CLEAN” mode → Click “OK” to activate



* The total cleaning time will vary according to the actual operating environment, and the longest time is 102 minutes for cooling and heating model.

ALL THE INSTALLATION WORKS GET EASY

Easy Indoor Unit Installation

41%
Faster in
Installation



Unlike ordinary AC's installation steps as below, Midea EOS installs faster and easier, making it more installer-friendly.



Multiple Position
Measurement & Adjustment



Complicated Wiring Steps
Difficult Connecting



Small Connection Space



Large Gap In Between

Easy Wiring In 3 Seconds

176mm large piping space with installation support clip.

Front-placed E-BOX for convenient access wiring just opening the front panel.

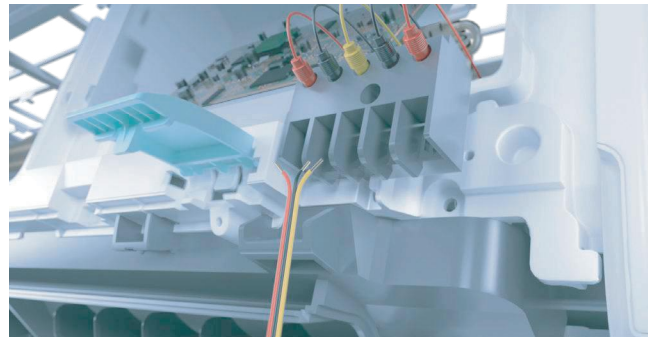
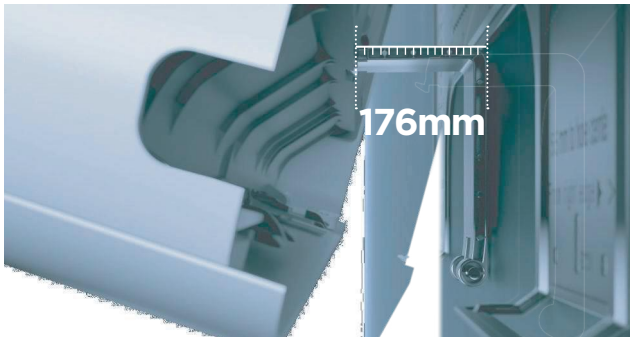

Easy Maintenance

76%
Faster in
PCB Replacement

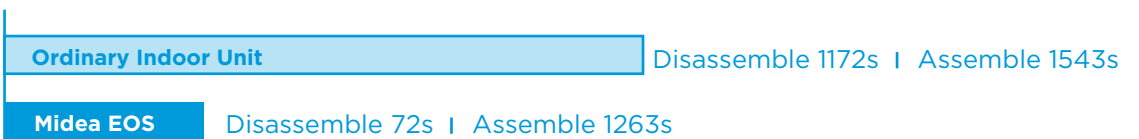

Ordinary Indoor Unit



Midea EOS



ALL THE INSTALLATION WORKS GET EASY

Easy Measure and Fix Without Extra Tools

Super slim mounting plate with built-in scale and horizontal meter. Measure, mark and fix with just one plate.

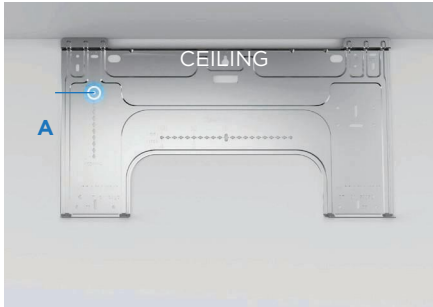

STEP 1: Mark the **SPOT A** according to the instruction of scale-on-plate

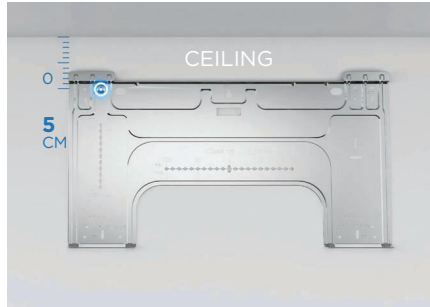

STEP 2: Move down the plate until the punch hole to the **SPOT A**

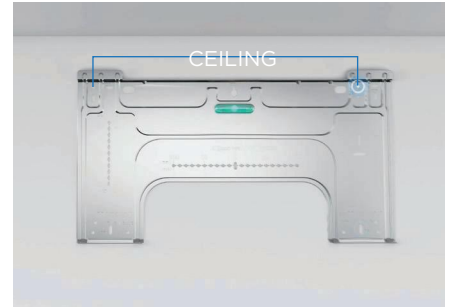

STEP 3: Locate the punch hole on other side with the Horizontal Meter on plate for precise levelling

Flexible Space Cooling Solution

Max. **25M** Piping Height and **50M** Piping Length. Requires Min. **5CM** Of Ceiling Distance

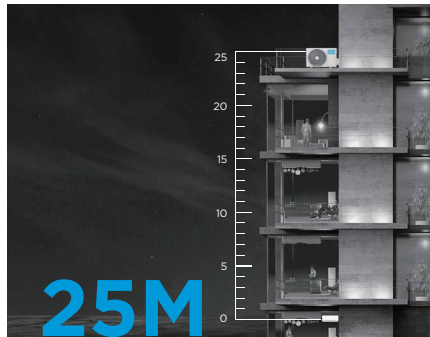
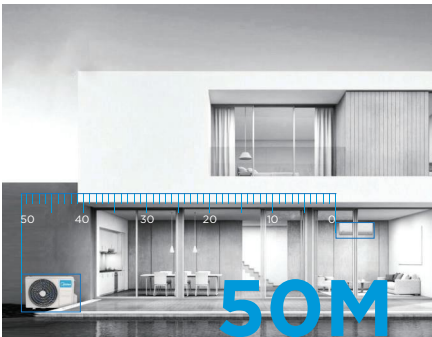

Easy Clean

No need to bother opening up the front panel anymore. Clean you filter as often as you want. 6 round magnetic connectors on the filter, the cover filter can be easily removed and put back just within 1 soft 'click'.



Easy to Clean

www.tuv.com
ID 1111238406

Easy to Cool with More Comfort

Quickly cools from corner to corner, so you're always comfortable wherever you are. Thanks to the front E-box and PCB design that releases more space for a larger airvolume in and out, the Midea EOS delivers you the stronger cooling performance with lower monthly energy bills.



50s Faster Cooling



7.7 meters Further Airflow

Easy to Cool with Less Energy

Thanks to the inverter technology, Midea EOS only consumes 1.13kw/h during a cool night with 8 hours. You can stay not only cool, but also stay green and energy efficient.

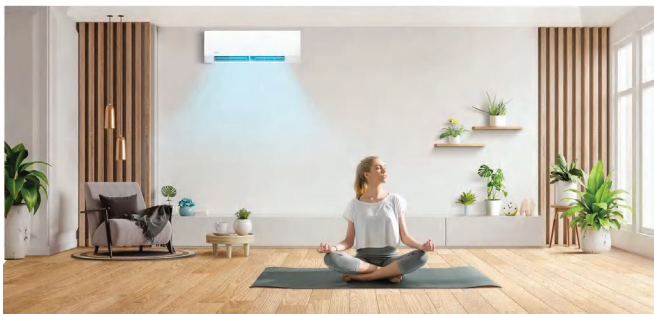

● ECOMASTER

- Presence detection for optimized operation
- Stable operation frequency as low as 12Hz



● 7 STARS ENERGY RATING

- 4th gen alpha chip with precise-control algorithm
- Inverter Quattro compressor with Step-less speed control

Easy to Cool with Smart

Wherever you are, you can keep your home comfortable using the Samrthome APP. Start up your air conditioner on the way home to enjoy crisp, cool air the moment you walk in the door. The possibilities for comfort and convenience are endless.

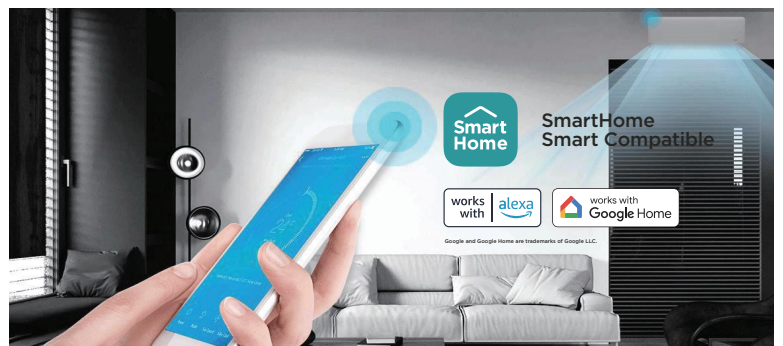

Product Specification



Midea EOS

Market Model		MFEP26VB-N/ MFEP26VB-W	MFEP35VB-N/ MFEP35VB-W	MFEP50VB-N/ MFEP50VB-W	MFEP60VB-N/ MFEP60VB-W	MFEP70VB-N/ MFEP70VB-W	MFEP80VB-N/ MFEP80VB-W	MFEP90VB-N/ MFEP90VB-W	
Remark		2.6kW	3.5kW	5.0kW	6.0kW	7.0kW	8.0kW	9.0kW	
Power supply	V-PH-HZ	220-240V, 1Ph,50Hz	220-240V, 1Ph,50Hz	220-240V, 1Ph,50Hz	220-240V, 1Ph,50Hz	220-240V, 1Ph,50Hz	220-240V, 1Ph,50Hz	220-240V, 1Ph,50Hz	
Cooling (Standard conditions)	Capacity	KW	2.63	3.5	5.05	6.00	7.20	8.00	9.00
	Min	KW	1.00	0.94	1.74	1.74	3.25	3.25	3.22
	Max	KW	3.83	3.90	6.39	6.39	8.56	8.56	9.38
	Input	W	487	750	1170	1575	1994	2375	2550
	Current	A	2.10	3.40	5.4	7.2	8.90	10.4	11.6
	EER	W/W	5.38	4.65	4.309	3.805	3.6	3.36	3.524
	Standby power	W	0.5	0.6	0.6	0.6	0.5	0.5	0.45
	AEER	W/W	5.38	4.65	4.309	3.805	3.6	3.36	3.524
	TCSPF (hot/Mix/cold)		8.979/8.26/8.711	8.04/7.52/8.05	7.51/6.93/7.39	6.572/6.224/6.642	6.009/5.717/6.108	5.691/5.443/5.84	5.725/5.505/5.898
	Seasonal star (hot zone)		7.0	6.5	6.0	5.0	4.5	4.0	4.0
	Seasonal star (Mixed zone)		6.5	6.0	5.0	4.5	4.0	3.5	4.0
Seasonal star (cold zone)		7.0	6.5	5.5	5.0	4.5	4.0	4.0	
Heating (Standard conditions)	Capacity	KW	2.7	3.90	6.0	6.6	8.2	9.0	9.8
	Min	KW	1.14	0.97	1.95	1.95	2.08	2.08	2.78
	Max	KW	3.95	4.34	6.90	6.90	9.20	9.20	9.96
	Input	W	499	851	1490	1760	2080	2430	2640
	Current	A	2.15	3.8	6.9	7.6	10.2	11.5	12.0
	COP	W/W	5.39	4.57	4.02	3.745	3.93	3.7	3.7
	Standby power	W	0.5	0.6	0.6	0.6	0.5	0.5	0.45
	ACOP	W/W	5.39	4.57	4.02	3.745	3.93	3.7	3.7
	HSPF (hot/Mix/cold)		5.831/5.442/5.002	5.708/5.011/4.502	5.529/4.64/4.007	5.549/4.505/3.808	5.276/4.508/3.935	5.197/4.331/3.711	5.118/4.247/3.6
	Seasonal star (hot zone)		4.0	4.0	4.0	4.0	3.5	3.5	3.5
	Seasonal star (Mixed zone)		3.5	3.5	3.0	3.0	3.0	2.5	2.5
Seasonal star (cold zone)		3.5	3.0	2.5	2.0	2.0	2.0	2.0	
Rated Power Input	W	2300	2300	3200	3400	4050	4050	4100	
Rated Current	A	10.0	10.5	15.5	15.5	17.5	17.5	18.0	
Connection wiring	MM ²	1.5x4	1.5x4	1.5x4	1.5x4	1.5x4	1.5x4	1.5x4	
Compressor	Type		ROTARY	ROTARY	ROTARY	ROTARY	ROTARY	ROTARY	
	Brand		HIGHLY	HIGHLY	GMCC	GMCC	GMCC	GMCC	
Indoor air flow (Turbo/Hi/Mi/Lo/Silence)	M ³ /H	840/580/ 415/330/316	740/540/ 415/330/316	1050/824/ 608/494/300	1050/824/ 608/494/300	1650/1555/ 1125/925/525	1650/1555/ 1125/925/525	1500/1230/ 960/840/600	
Indoor noise level Turbo/(Hi/Mi/Lo/Silence)	DB(A)	38.5/33/23/19	40.5/33.5/30.5/20	42/35/33/27	42/35/33/27	50/43/37/26	50/43/37/26	47/41.5/35/24.5	
Indoor noise level (sound power level)	DB(A)	56.6	60	61.5	61.9	62.8	62.8	64.8	
Indoor unit	Dimension (W*D*H)	MM	795x225x295	795x225x295	965x239x319	965x239x319	1140x275x370	1140x275x370	1140x275x370
	Packing (W*D*H)	MM	870x370x305	870x370x305	1045x400x325	1045x400x325	1230x455x355	1230x455x355	1230x455x355
	Net/Gross weight	KG	10.0/12.8	9.9/12.7	11.8/15.7	11.8/15.7	17.2/22.2	17.2/22.2	18.9/24.0
Outdoor air flow	M ³ /H	2100	2200	3500	3500	3500	3500	4000	
Outdoor noise level (sound pressure level)	DB(A)	55.0	55.0	59	59	61	61.0	61.0	
Outdoor noise level (sound power level)	DB(A)	63.7	60.0	65.8	66.2	67	67	69.7	
Outdoor unit	Dimension (W*D*H)	MM	765x303x555	805x330x554	890x342x673	890x342x673	890x342x673	890x342x673	946x410x810
	Packing (W*D*H)	MM	887x337x610	915x370x615	1030x438x750	1030x438x750	1030x438x750	1030x438x750	1090x500x885
	Net/Gross weight	KG	29.4/31.6	31.8/34.3	42.3/45.6	42.3/45.6	43.8/47.2	43.8/47.2	60.3/64.6
Refrigerant type (Units pre-charged for 10m pipe run)	KG	R32/0.85	R32/0.9	R32/1.2	R32/1.2	R32/1.4	R32/1.4	R32/2.2	
Operation temperature	°C	16-30	16-30	16-30	16-30	16-30	16-30	16-30	
Room temperature	Indoor (cooling/ heating)	°C	16 ~ 32/0 ~ 30	16 ~ 32/0 ~ 30	16 ~ 32/0 ~ 30	16 ~ 32/0 ~ 30	16 ~ 32/0 ~ 30	16 ~ 32/0 ~ 30	16 ~ 32/0 ~ 30
	Outdoor (cooling/heating)	°C	-15 ~ 50/-15 ~ 24	-15 ~ 50/-15 ~ 24	-15 ~ 50/-15 ~ 24	-15 ~ 50/-15 ~ 24	-15 ~ 50/-15 ~ 24	-15 ~ 50/-15 ~ 24	-15 ~ 50/-15 ~ 24
Application area (Cooling Standard)	M ²	12 ~ 17	16 ~ 23	23 ~ 33	27 ~ 40	33 ~ 48	36 ~ 53	41 ~ 60	
Refrigerant piping	Liquid side	mm(inch)	6.35mm(1/4in)	6.35mm(1/4in)	6.35mm(1/4in)	6.35mm(1/4in)	6.35mm(1/4in)	6.35mm(1/4in)	9.52mm(3/8in)
	Gas side	mm(inch)	9.52mm(3/8in)	9.52mm(3/8in)	12.7mm(1/2in)	12.7mm(1/2in)	15.9mm(5/8in)	15.9mm(5/8in)	15.9mm(5/8in)

World's No.1 Residential Inverter Air Conditioner Company For 2 Consecutive Years



1. Data source: Euromonitor International (Shanghai) Limited; Consumer Appliances 2026ed, retail volume sales in units, 2024 to 2025 data.

Midea HVAC & Energy Australia
MD APPLIANCES PTY LTD
Head Office Address: 1513 Dandenong Road, Oakleigh VIC Australia
Phone: 1300 726 002
Website: mdhome.com.au
Email: info@mdhome.com.au