

**WINDOW TYPE ROOM AIR CONDITIONER**

# **USER MANUAL**

**MWFF22H  
MWFF28H**



Warning notices: Before using this product, please read this manual carefully and keep it for future reference. The design and specifications are subject to change without prior notice for product improvement. Consult with your dealer or manufacturer for details. The diagram above is just for reference. Please take the appearance of the actual product as the standard.



## THANK YOU LETTER

Thank you for choosing Midea! Before using your new Midea product, please read this manual thoroughly to ensure that you know how to operate the features and functions that your new appliance offers in a safe way.

## CONTENTS

<b>THANK YOU LETTER</b> .....	<b>01</b>
<b>SAFETY PRECAUTIONS</b> .....	<b>02</b>
<b>SPECIFICATIONS</b> .....	<b>11</b>
<b>PRODUCT OVERVIEW</b> .....	<b>12</b>
<b>PRODUCTION INSTALLATION</b> .....	<b>13</b>
<b>OPERATION INSTRUCTIONS</b> .....	<b>16</b>
Operation panel .....	16
Air direction control .....	18
Water drainage .....	19
<b>REMOTE CONTROLLER SPECIFICATIONS</b> .....	<b>20</b>
<b>CARE AND MAINTENANCE</b> .....	<b>33</b>
<b>TROUBLESHOOTING</b> .....	<b>34</b>
<b>TRADEMARKS, COPYRIGHTS AND LEGAL STATEMENT</b> .....	<b>36</b>
<b>DISPOSAL AND RECYCLING</b> .....	<b>36</b>
<b>DATA PROTECTION NOTICE</b> .....	<b>37</b>

# SAFETY PRECAUTIONS

It's really important you read Safety Precautions Before Operation and Installation. Incorrect installation due to ignoring instructions can cause serious damage or injury. The seriousness of potential damage or injuries is classified as either a **WARNING** or **CAUTION**.

## Explanation of Symbols



### **WARNING**

This symbol indicates the possibility of personnel injury or loss of life.



### **CAUTION**

This symbol indicates the possibility of property damage or serious consequences.



### **WARNING**

This appliance is not intended for use by persons (including children) with reduced physical, sensory or mental capabilities, or lack of experience and knowledge, unless they have been given supervision or instruction concerning use of the appliance by a person responsible for their safety. Children should be supervised to ensure that they do not play with the appliance.



### **WARNINGS FOR PRODUCT USE**

- If an abnormal situation arises (like a burning smell), immediately turn off the unit and disconnect the power. Call your dealer for instructions to avoid electric shock, fire or injury.
- Do not insert fingers, rods or other objects into the air inlet or outlet. This may cause injury, since the fan may be rotating at high speeds.
- Do not use flammable sprays such as hair spray, lacquer or paint near the unit. This may cause fire or combustion.
- Do not install the air conditioner in places near or around combustible gases. Emitted gas may collect around the unit and cause explosion.
- Do not operate your air conditioner in a wet room such as a bathroom or laundry room. Too much exposure to water can cause electrical components to short circuit.
- Do not expose your body directly to cool air for a prolonged period of time.
- Do not allow children to play with the air conditioner. Children must be supervised around the unit at all times.
- If the air conditioner is used together with burners or other heating devices, thoroughly ventilate the room to avoid oxygen deficiency.
- In certain functional environments, such as kitchens, server rooms, etc., the use of specially designed air-conditioning units is highly recommended.
- Unplug the unit or disconnect the power supply to the unit if strange sounds, smell, or smoke comes from it.
- To further optimize the performance of your unit, keep doors and windows closed during operation.
- Pay attention when unpacking and installing. Sharp edges could cause injury.

## **CLEANING AND MAINTENANCE WARNINGS**

- Turn off the device and disconnect the power before cleaning. Failure to do so can cause electrical shock.
- Do not clean the air conditioner with excessive amounts of water.
- Do not clean the air conditioner with combustible cleaning agents. Combustible cleaning agents can cause fire or deformation.

## **⚠ CAUTION**

- Turn off the air conditioner and disconnect the power if you are not going to use it for a long time.
- Make sure that water condensation can drain unhindered from the unit.
- Do not operate the air conditioner with wet hands. This may cause electric shock.
- Do not use device for any other purpose than its intended use.
- Do not climb onto or place objects on top of the outdoor unit.
- Do not allow the air conditioner to operate for long periods of time with doors or windows open, or if the humidity is very high.

## **⚠ ELECTRICAL WARNINGS**

- Only use the specified power cord. If the power cord is damaged, it must be replaced by the manufacturer, its service agent or similarly qualified persons in order to avoid a hazard.
- Keep power plug clean. Remove any dust or grime that accumulates on or around the plug. Dirty plugs can cause fire or electric shock.
- Do not pull power cord to unplug unit. Hold the plug firmly and pull it from the outlet. Pulling directly on the cord can damage it, which can lead to fire or electric shock.
- Do not modify the length of the power supply cord or use an extension cord to power the unit.
- Do not share the electrical outlet with other appliances. Improper or insufficient power supply can cause fire or electrical shock. Always install circuit breaker and a dedicated power circuit.
- Do not use the socket if it is loose or damaged.
- Do not place heavy object on the power cord and ensure that the cord is not compressed.
- There is danger of fire or electric shock.
- If water enters the unit, turn the unit off at the power outlet and switch off the circuit breaker.
- Isolate supply by taking the power-plug out or disconnect the power supply to the unit, contact a qualified service technician.
- The product must be properly grounded at the time of installation, or electrical shock may occur.
- For all electrical work, follow all local and national wiring standards, regulations, and the Electrical Connection Diagram located on the top panel of the unit.
- If connecting power to fixed wiring, an all-pole disconnection device which has at least 3mm clearances in all poles, and have a leakage current that may exceed 10mA, the residual current device(RCD) having a rated residual operating current not exceeding 30mA, and disconnection must be incorporated in the fixed wiring in accordance with the wiring rules.
- This unit is earthed through the power cord, make sure that the unit is correctly grounded. The wall outlet(Air-break switch) should be provided with reliable earth wire. The unit should be provided with an individual circuit and the circuit breaker/fuse rating should be the same as that of the power cord and wall outlet. Power cord conductors are distinguished according to the color as shown in Wiring Diagram located on the top of the machine.

## TAKE NOTE OF FUSE SPECIFICATIONS

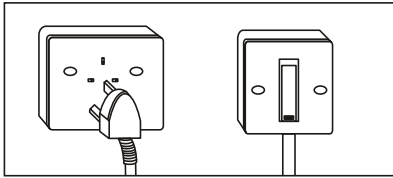

Wall outlet    Air-break switch

The air conditioner's circuit board (PCB) is designed with a fuse to provide overcurrent protection. The specifications of the fuse are printed on the circuit board, such as T3.15A/250V(or 350V), etc,

## ⚠️ WARNINGS FOR PRODUCT INSTALLATION

- Installation must be performed by an authorized dealer or specialist. Defective installation can cause water leakage, electrical shock, or fire.
- Installation must be performed according to the installation instructions. Improper installation can cause water leakage, electrical shock, or fire.
- Contact an authorized service technician for repair or maintenance of this unit. This appliance shall be installed in accordance with national wiring regulations.
- Only use the included accessories, parts, and specified parts for installation. Using non-standard parts can cause water leakage, electrical shock, fire, and can cause the unit to fail.
- Install the unit in a firm location that can support the unit's weight. If the chosen location cannot support the unit's weight, or the installation is not done properly, the unit may drop and cause serious injury and damage.
- Install drainage piping according to the instructions in this manual. Improper drainage may cause water damage to your home and property.
- For units that have an auxiliary electric heater, do not install the unit within 1 meter (3 feet) of any combustible materials.
- Do not install the unit in a location that may be exposed to combustible gas leaks. If combustible gas accumulates around the unit, it may cause fire.
- Do not turn on the power until all work has been completed.
- When moving or relocating the air conditioner, consult experienced service technicians for disconnection and reinstallation of the unit.
- How to install the appliance to its support, please read the information for details in "Installation instructions" section.

## Operating temperature

When your air conditioner is used outside of the following temperature ranges, certain safety protection features may activate and cause the unit to disable.

Cooling operation	Outdoor Temperature	18°C-43°C (64°F-109°F)
		18°C-52°C (64°F-126°F) (For special tropical models)
	Indoor Temperature	17°C-32°C (62°F-90°F)
Heating operation	Outdoor Temperature	-5°C-24°C (23°F-76°F)
	Indoor Temperature	0°C-27°C (32°F-80°F)

## To further optimize the performance of your unit, do the following:

- Keep doors and windows closed.
- The capacity of the room air conditioner must fit the room size for efficient and satisfactory operation.
- Do not block air inlets or outlets.
- Regularly inspect and clean air filters.
- If the power supplied to the unit is not plus/minus 10% of the specified rating, the unit may not function and the fuse may blow.
- Noise from the air conditioner will be louder at night than in the daytime. This is because the noise in the surroundings is comparatively low at night. If you feel that the noise is too loud, switch the thermostat to lower numbers.

## Note about Fluorinated Gasses

1. Fluorinated greenhouse gases are contained in hermetically sealed equipment. For specific information on the type, the amount and the CO<sub>2</sub> equivalent in tonnes of the fluorinated greenhouse gas (on some models), please refer to the relevant label on the unit itself.
2. Installation, service, maintenance and repair of this unit must be performed by a certified technician.
3. Product uninstallation and recycling must be performed by a certified technician.

## DISPOSAL AND RECYCLING

### Important instructions for environment (European Disposal Guidelines)

Compliance with the WEEE Directive and Disposing of the Waster Product:

This product complies with EU WEEE Directive. This product bears a classification symbol for waster electrical and electronic equipment (WEEE).

This symbol indicates that this product shall not be disposed with other household wastes at the end of its service life. Used device must be returned to official collection point for recycling of electrical electronic devices. To find these collection systems please contact to your local authorities or retailer where the product was purchased. Each household performs important role in recovering and recycling of old appliance. Appropriate disposal of used appliance helps prevent potential negative consequences for the environment and human health.

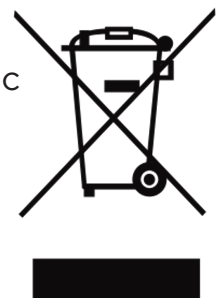

## **⚠ WARNING for Using R32/R290 Refrigerant**

- Do not use means to accelerate the defrosting process or to clean, other than those recommended by the manufacturer.
- The appliance shall be stored in a room without continuously operating ignition sources (for example: open flames, an operating gas appliance) and ignition sources (for example: an operating electric heater) close to the appliance. The appliance shall be stored in a room without continuously operating ignition sources (for example: open flames, an operating gas appliance or an operating electric heater).
- Do not pierce or burn.
- Be aware that the refrigerants may not contain an odour.
- Compliance with national gas regulations shall be observed.
- Keep ventilation openings clear of obstruction.
- The appliance shall be stored so as to prevent mechanical damage from occurring.
- A warning that the appliance shall be stored in a well-ventilated area where the room size corresponds to the room area as specified for operation.
- Any person who is involved with working on or breaking into a refrigerant circuit should hold a current valid certificate from an industry-accredited assessment authority, which authorises their competence to handle refrigerants safely in accordance with an industry recognised assessment specification.
- Servicing shall only be performed as recommended by the equipment manufacturer. Maintenance and repair requiring the assistance of other skilled personnel shall be carried out under the supervision of the person competent in the use of flammable refrigerants.
- Please follow the instruction carefully to handle, install, clear, service the air conditioner to avoid any damage or hazard. Flammable Refrigerant R32 is used within air conditioner. When maintaining or disposing the air conditioner, the refrigerant (R32 or R290) shall be recovered properly, shall not discharge to air directly.
- No any open fire or device like switch which may generate spark/arcing shall be around air conditioner to avoid causing ignition of the flammable refrigerant used. Please follow the instruction carefully to store or maintain the air conditioner to prevent mechanical damage from occurring.
- Flammable refrigerant is used in air conditioner. Please follow the instruction carefully to avoid any hazard.







Caution: Risk of fire/  
flammable materials  
(Required for R32/  
R290 units only)



Warning: low burning  
velocity material  
(For R32 models apply  
to IEC60335-2-40:2018)

### **Explanation of symbols displayed (For the unit adopts R32/R290 Refrigerant only):**

		<b>WARNING</b>	This symbol shows that this appliance used a flammable refrigerant. If the refrigerant is leaked and exposed to an external ignition source, there is a risk of fire.
	<b>CAUTION</b>	This symbol shows that the operation manual should be read carefully.	
	<b>CAUTION</b>	This symbol shows that a service personnel should be handling this equipment with reference to the installation manual.	
	<b>CAUTION</b>	This symbol shows that information is available such as the operating manual or installation manual.	

1. Transport of equipment containing flammable refrigerants See transport regulations
2. Marking of equipment using signs See local regulations.
3. Disposal of equipment using flammable refrigerants See national regulations.
4. Storage of equipment/appliances The storage of equipment should be in accordance with the manufacturer's instructions.
5. Storage of packed (unsold) equipment Storage package protection should be constructed such that mechanical damage to the equipment inside the package will not cause a leak of the refrigerant charge. The maximum number of pieces of equipment permitted to be stored together will be determined by local regulations.
6. Information on servicing
  - 1) Checks to the area  
Prior to beginning work on systems containing flammable refrigerants, safety checks are necessary to ensure that the risk of ignition is minimised. For repair to the refrigerating system, the following precautions shall be complied with prior to conducting work on the system.
  - 2) Work procedure  
Work shall be undertaken under a controlled procedure so as to minimise the risk of a flammable gas or vapour being present while the work is being performed.
  - 3) General work area  
All maintenance staff and others working in the local area shall be instructed on the nature of work being carried out. Work in confined spaces shall be avoided. The area around the workspace shall be sectioned off. Ensure that the conditions within the area have been made safe by control of flammable material.
  - 4) Checking for presence of refrigerant  
The area shall be checked with an appropriate refrigerant detector prior to and during work, to ensure the technician is aware of potentially flammable atmospheres. Ensure that the leak detection equipment being used is suitable for use with flammable refrigerants, i.e. non-sparking, adequately sealed or intrinsically safe.
  - 5) Presence of fire extinguisher  
If any hot work is to be conducted on the refrigeration equipment or any associated parts, appropriate fire extinguishing equipment shall be available to hand. Have a dry powder or CO<sub>2</sub> fire extinguisher adjacent to the charging area.
  - 6) No ignition sources  
No person carrying out work in relation to a refrigeration system which involves exposing any pipe work that contains or has contained flammable refrigerant shall use any sources of ignition in such a manner that it may lead to the risk of fire or explosion. All possible ignition sources, including cigarette smoking, should be kept sufficiently far away from the site of installation, repairing, removing and disposal, during which flammable refrigerant can possibly be released to the surrounding space. Prior to work taking place, the area around the equipment is to be surveyed to make sure that there are no flammable hazards or ignition risks. No Smoking signs shall be displayed.
  - 7) Ventilated area  
Ensure that the area is in the open or that it is adequately ventilated before breaking into the system or conducting any hot work. A degree of ventilation shall continue during the period that the work is carried out. The ventilation should safely disperse any released refrigerant and preferably expel it externally into the atmosphere.
  - 8) Checks to the refrigeration equipment  
Where electrical components are being changed, they shall be fit for the purpose and to the correct specification. At all times the manufacturer's maintenance and service guidelines shall be followed. If in doubt consult the manufacturer's technical department for assistance. The following checks shall be applied to installations using flammable refrigerants: The charge size is in accordance with the room size within which the refrigerant containing parts are installed;  
The ventilation machinery and outlets are operating adequately and are not obstructed; If an indirect refrigerating circuit is being used, the secondary circuit shall be checked for the presence of refrigerant; Marking to the equipment continues to be visible and legible.

Markings and signs that are illegible shall be corrected;

Refrigeration pipe or components are installed in a position where they are unlikely to be exposed to any substance which may corrode refrigerant containing components, unless the components are constructed of materials which are inherently resistant to being corroded or are suitably protected against being so corroded.

#### 9)Checks to electrical devices

Repair and maintenance to electrical components shall include initial safety checks and component inspection procedures. If a fault exists that could compromise safety, then no electrical supply shall be connected to the circuit until it is satisfactorily dealt with. If the fault cannot be corrected immediately but it is necessary to continue operation, an adequate temporary solution shall be used. This shall be reported to the owner of the equipment so all parties are advised.

Initial safety checks shall include:

That capacitors are discharged: this shall be done in a safe manner to avoid possibility of sparking; That there no live electrical components and wiring are exposed while charging, recovering or purging the system; That there is continuity of earth bonding.

#### 7.Repairs to sealed components

1)During repairs to sealed components, all electrical supplies shall be disconnected from the equipment

being worked upon prior to any removal of sealed covers, etc. If it is absolutely necessary to have an electrical supply to equipment during servicing, then a permanently operating form of leak detection shall be located at the most critical point to warn of a potentially hazardous situation.

2)Particular attention shall be paid to the following to ensure that by working on electrical components, the casing is not altered in such a way that the level of protection is affected. This shall include damage to cables, excessive number of connections, terminals not made to original specification, damage to seals, incorrect fitting of glands, etc. Ensure that apparatus is mounted securely. Ensure that seals or sealing materials have not degraded such that they no longer serve the purpose of preventing the ingress of flammable atmospheres. Replacement parts shall be in accordance with the manufacturer's specifications.

NOTE: The use of silicon sealant may inhibit the effectiveness of some types of leak detection equipment. Intrinsically safe components do not have to be isolated prior to working on them.

#### 8.Repair to intrinsically safe components

Do not apply any permanent inductive or capacitance loads to the circuit without ensuring that this will not exceed the permissible voltage and current permitted for the equipment in use. Intrinsically safe components are the only types that can be worked on while live in the presence of a flammable atmosphere. The test apparatus shall be at the correct rating. Replace components only with parts specified by the manufacturer. Other parts may result in the ignition of refrigerant in the atmosphere from a leak.

#### 9.Cabling

Check that cabling will not be subject to wear, corrosion, excessive pressure, vibration, sharp edges or any other adverse environmental effects. The check shall also take into account the effects of aging or continual vibration from sources such as compressors or fans.

#### 10.Detection of flammable refrigerants

Under no circumstances shall potential sources of ignition be used in the searching for or detection of refrigerant leaks. A halide torch (or any other detector using a naked flame) shall not be used.

## 11. Leak detection methods

The following leak detection methods are deemed acceptable for systems containing flammable refrigerants. Electronic leak detectors shall be used to detect flammable refrigerants, but the sensitivity may not be adequate, or may need re-calibration. (Detection equipment shall be calibrated in a refrigerant-free area.) Ensure that the detector is not a potential source of ignition and is suitable for the refrigerant used. Leak detection equipment shall be set at a percentage of the LFL of the refrigerant and shall be calibrated to the refrigerant employed and the appropriate percentage of gas (25 % maximum) is confirmed.

### Leak detection fluids

are suitable for use with most refrigerants but the use of detergents containing chlorine shall be avoided as the chlorine may react with the refrigerant and corrode the copper pipe-work. If a leak is suspected, all naked flames shall be removed/extinguished. If a leakage of refrigerant is found which requires brazing, all of the refrigerant shall be recovered from the system, or isolated (by means of shut off valves) in a part of the system remote from the leak. Oxygen free nitrogen (OFN) shall then be purged through the system both before and during the brazing process.

## 12. Removal and evacuation

When breaking into the refrigerant circuit to make repairs or for any other purpose conventional procedures shall be used. However, it is important that best practice is followed since flammability is a consideration. The following procedure shall be adhered to: Remove refrigerant; Purge the circuit with inert gas; Evacuate; Purge again with inert gas; Open the circuit by cutting or brazing.

The refrigerant charge shall be recovered into the correct recovery cylinders. The system shall be flushed with OFN to render the unit safe. This process may need to be repeated several times. Compressed air or oxygen shall not be used for this task. Flushing shall be achieved by breaking the vacuum in the system with OFN and continuing to fill until the working pressure is achieved, then venting to atmosphere, and finally pulling down to a vacuum. This process shall be repeated until no refrigerant is within the system. When the final OFN charge is used, the system shall be vented down to atmospheric pressure to enable work to take place. This operation is absolutely vital if brazing operations on the pipe-work are to take place. Ensure that the outlet for the vacuum pump is not close to any ignition sources and there is ventilation available.

## 13. Charging procedures

In addition to conventional charging procedures, the following requirements shall be followed. Ensure that contamination of different refrigerants does not occur when using charging equipment. Hoses or lines shall be as short as possible to minimise the amount of refrigerant contained in them. Cylinders shall be kept upright.

Ensure that the refrigeration system is earthed prior to charging the system with refrigerant. Label the system when charging is complete (if not already).

Extreme care shall be taken not to overfill the refrigeration system. Prior to recharging the system it shall be pressure tested with OFN. The system shall be leak tested on completion of charging but prior to commissioning. A follow up leak test shall be carried out prior to leaving the site.

## 14. Decommissioning

Before carrying out this procedure, it is essential that the technician is completely familiar with the equipment and all its detail. It is recommended good practice that all refrigerants are recovered safely. Prior to the task being carried out, an oil and refrigerant sample shall be taken in case analysis is required prior to re-use of reclaimed refrigerant. It is essential that electrical power is available before the task is commenced.

- a) Become familiar with the equipment and its operation.
- b) Isolate system electrically.
- c) Before attempting the procedure ensure that: Mechanical handling equipment is available, if required, for handling refrigerant cylinders; All personal protective equipment is available and being used correctly; The recovery process is supervised at all times by a competent person; Recovery equipment and cylinders conform to the appropriate standards.
- d) Pump down refrigerant system, if possible.
- e) If a vacuum is not possible, make a manifold so that refrigerant can be removed from various parts of the system.
- f) Make sure that cylinder is situated on the scales before recovery takes place.
- g) Start the recovery machine and operate in accordance with manufacturer's instructions.
- h) Do not overfill cylinders. (No more than 80 % volume liquid charge).
- i) Do not exceed the maximum working pressure of the cylinder, even temporarily.
- j) When the cylinders have been filled correctly and the process completed, make sure that the cylinders and the equipment are removed from site promptly and all isolation valves on the equipment are closed off.
- k) Recovered refrigerant shall not be charged into another refrigeration system unless it has been cleaned and checked. cylinders. (No more than 80 % volume liquid charge).
- i) Do not exceed the maximum working pressure of the cylinder, even temporarily.
- j) When the cylinders have been filled correctly and the process completed, make sure that the cylinders and the equipment are removed from site promptly and all isolation valves on the equipment are closed off.
- k) Recovered refrigerant shall not be charged into another refrigeration system unless it has been cleaned and checked.

#### 15. Labelling

Equipment shall be labelled stating that it has been de-commissioned and emptied of refrigerant. The label shall be dated and signed. Ensure that there are labels on the equipment stating the equipment contains flammable refrigerant.

#### 16. Recovery

When removing refrigerant from a system, either for servicing or decommissioning, it is recommended good practice that all refrigerants are removed safely. When transferring refrigerant into cylinders, ensure that only appropriate refrigerant recovery cylinders are employed. Ensure that the correct number of cylinders for holding the total system charge is available. All cylinders to be used are designated for the recovered refrigerant and labelled for that refrigerant (i.e. special cylinders for the recovery of refrigerant). Cylinders shall be complete with pressure relief valve and associated shut-off valves in good working order. Empty recovery cylinders are evacuated and, if possible, cooled before recovery occurs. The recovery equipment shall be in good working order with a set of instructions concerning the equipment that is at hand and shall be suitable for the recovery of flammable refrigerants. In addition, a set of calibrated weighing scales shall be available and in good working order. Hoses shall be complete with leak-free disconnect couplings and in good condition. Before using the recovery machine, check that it is in satisfactory working order, has been properly maintained and that any associated electrical components are sealed to prevent ignition in the event of a refrigerant release.

Consult manufacturer if in doubt. The recovered refrigerant shall be returned to the refrigerant supplier in the correct recovery cylinder, and the relevant Waste Transfer Note arranged. Do not mix refrigerants in recovery units and especially not in cylinders. If compressors or compressor oils are to be removed, ensure that they have been evacuated to an acceptable level to make certain that flammable refrigerant does not remain within the lubricant. The evacuation process shall be carried out prior to returning the compressor to the suppliers. Only electric heating to the compressor body shall be employed to accelerate this process. When oil is drained from a system, it shall be carried out safely.

# SPECIFICATIONS

Product Model	MWFF22H	MWFF28H
Power source	220-240V~ 50Hz, 1Ph	
Cooling capacity	2.28kW	2.80kW
Heating capacity	2.00kW	2.45kW
Rated current	/	/
Rated power input	/	/
Outside resistance class	IPX4	

# PRODUCT OVERVIEW

## NOTE ON ILLUSTRATIONS:

All the illustrations in the manual are for explanation purpose only. Your machine may be slightly different. The actual shape shall prevail. The unit can be controlled by the unit control panel alone or with the remote controller.

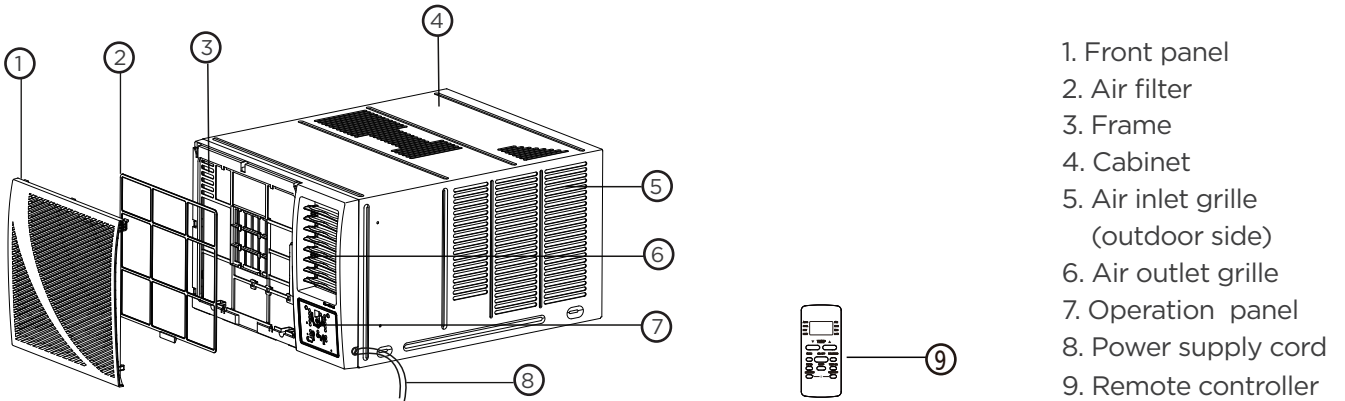

1. Front panel
2. Air filter
3. Frame
4. Cabinet
5. Air inlet grille  
(outdoor side)
6. Air outlet grille
7. Operation panel
8. Power supply cord
9. Remote controller

## Accessories

Seal(※)(Used on drain joint)



1 pc

Rubber Plug

Drain Joint(※)



1 pc

Screw

Drain pan(※)



1 pc

Wooden screw (optional)(※)

Sponge(※)



1 pc

Sponge(※)



1 pc

Rubber Plug



1-2 pc  
(depending on models)

Screw



2 pcs(For some units) used  
to fasten the front panel

2 pcs or 4 pcs used to install  
the drain pan

PVC sheath and cable ties(※)

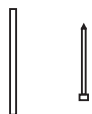

1 pc 4 pcs

Remote Controller and Battery

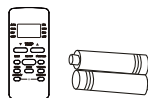

1 pc

[※] Model dependent

# PRODUCTION INSTALLATION

## 1 Select the best location

### NOTE

Before installing, remove all packaging from inside the carton, along with any inserts placed into the side louvers.

1. To avoid vibration and noise, make sure the unit is installed securely and firmly.
2. Install the unit where the sunlight does not shine directly on the unit. If the unit receives direct sunlight, build an awning to shade the cabinet.
3. There should be no obstacle, such as a fence or wall, within 50cm from the back of the cabinet because it will prevent heat radiation of the condenser. Restriction of outside air will greatly reduce the cooling and heating efficiency of the air conditioner.
4. Install the unit a little obliquely downward to outside not to leak the condensed water into the room (about 3-4°).
5. Install the unit with its bottom portion 75-150cm above the floor level.
6. The power cord must be connected to an independent circuit. The yellow/green wire must be grounded.

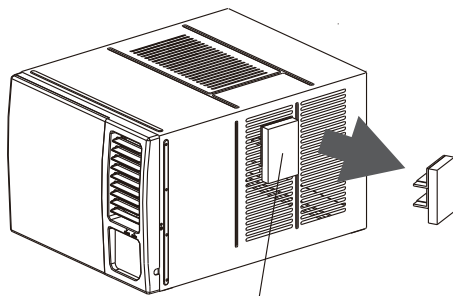

Remove inserts placed into the side louvers at first.

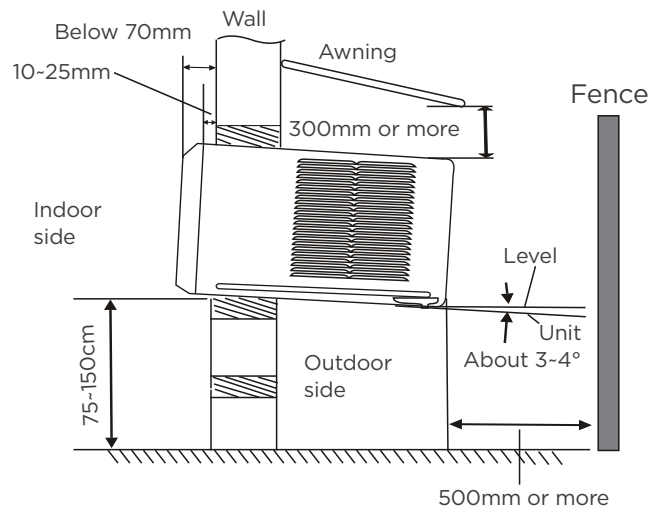

### CAUTION

All side louvers of the cabinet must remain exposed to the outside of the structure.

Option A

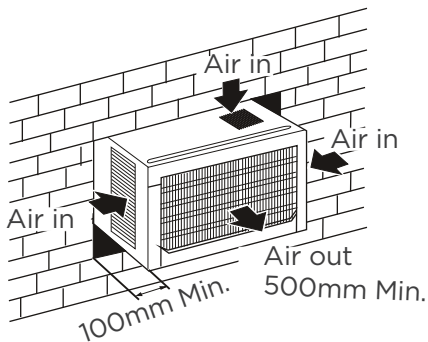

Option B

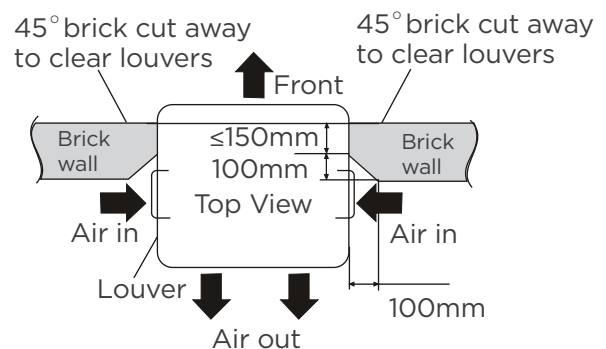

## 2 Prior to installation

### Remove the cabinet

**NOTE:** There are slight differences on removing the cabinet according to the different models.

1. Remove one screw securing the chassis fixing bracket, then take down the chassis fixing bracket as shown in Fig.1
2. Grasp the handle on the chassis and carefully slide the air conditioner out of the cabinet.(see Fig.2)

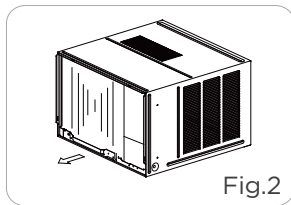
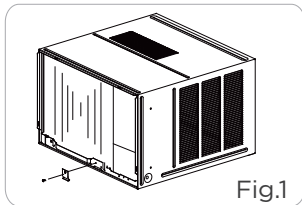

## 3 Install the cabinet

### Step 1: Install the cabinet

**NOTE:** Unit may be supported by a solid frame from below or by a hanger from a solid overhead support(not supplied, purchase separately, please contact the dealer).

1. When need to drain off water, install the drain plug on the chassis board.
2. Prepare the hole in the wall so that the bottom of the cabinet is well supported, the top has minimum clearance and the air inlet louvers have clearance as shown in previous page (Fig. Option A & B). Holes from the outside through to the cavity should be sealed. The cabinet should slop down towards the rear by about 3-4° to allow water formed during operation to drain.
3. Install the cabinet into the wall and secure. Ensure the foam seals are not damaged. Flash, seal or fill gaps around the inside and outside to provide satisfactory appearance and protection against the weather, insects and rodents. (see Fig.3)

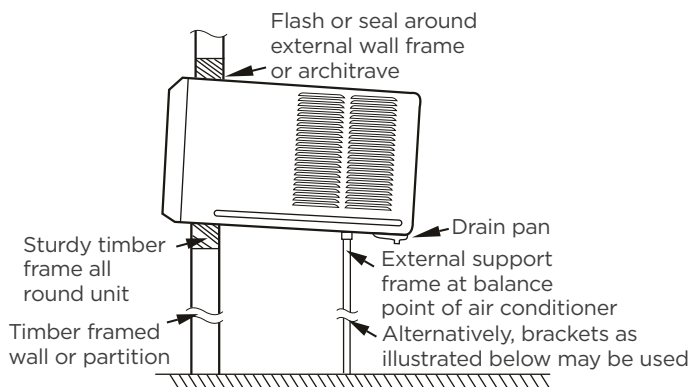

Preferred method of installation into a timber framed wall, partition or window

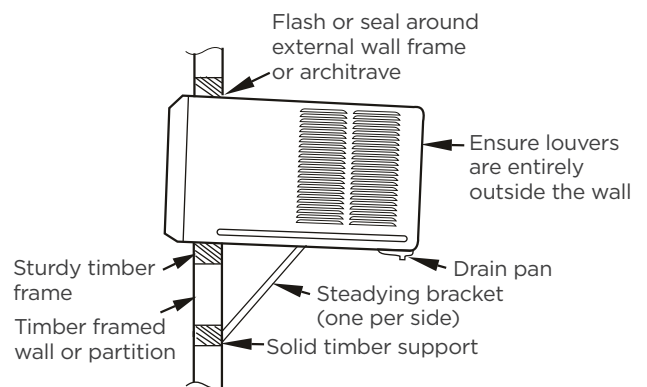

Alternative method of installation if external support can not be provided

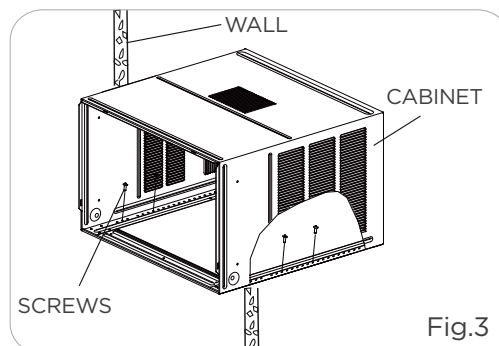

## Step 2: Install the unit into the cabinet

1. Slide the unit into the cabinet until it is firmly against the rear of the cabinet. Care is required to ensure the foam sealing strips on the cabinet remain in position (See Fig.4).
2. Connect the air conditioner to the power and position excess cord length beneath the air conditioner base.
3. Engage the chassis fixing brackets into the bottom cabinet rail and secure to the base with the screw provided.(See Fig.5).

Before installing the frame:

1. open the box and take out the wire terminals.
2. Align the wire terminals with the display box terminals on the frame.

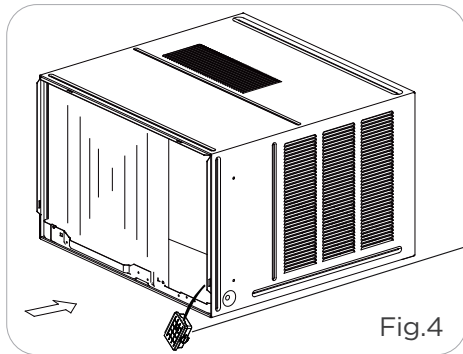
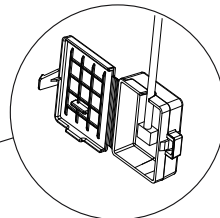

Fig.4



Take out the wire terminals

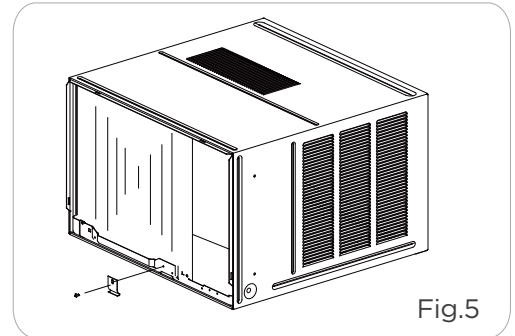

Fig.5

## Step 3: Install the frame

1. Hook the upper edge of the frame(see Fig.6).
2. Press the both side and lower edge of the frame, and secure it with the two screws at the bottom of the frame.( See Fig. 7)

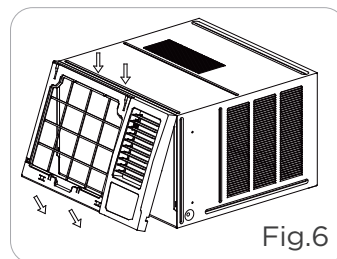

Fig.6

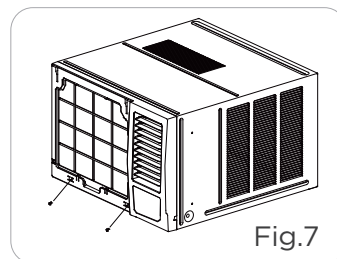

Fig.7

## Step 4: Install the air filter and front panel

1. Insert the air filter into the frame's slot from upside to underside. (See Fig. 8)
2. Hang the front panel on the frame's buckle, then press the front panel into the frame's slot until you hear a click (see Fig.9).
3. Switch unit on. Check for operation of the unit and check for vibration after installation.
4. Fit the drain pan to the cabinet and run a drain hose to a suitable location if required.

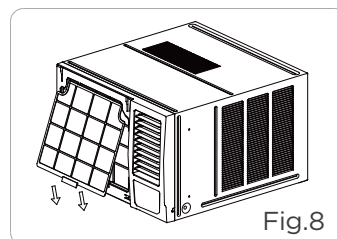

Fig.8

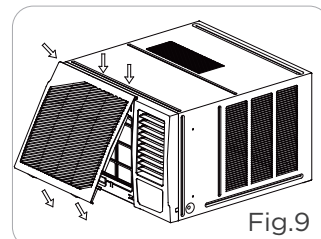

Fig.9

# OPERATION INSTRUCTIONS

## Operation panel

### NOTE:

Different models have different operation panels. Not all the functions describing below are available for the air conditioner you purchased. Please check the operation panel of the unit you purchased. The following graphics are for explanatory purposes. The actual shape shall prevail.

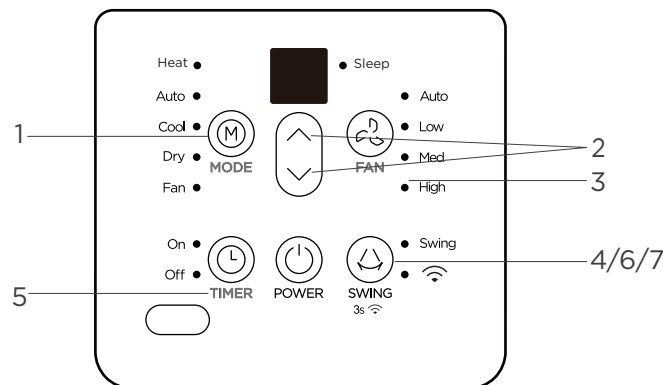

**POWER:** Press the POWER keypad to turn the unit on/off.

## 1.MODE

Press the "MODE" keypad to select the appropriate operating mode. The mode selection will alternate between AUTO, HEAT (cooling only models without), COOL, FAN and DRY. The indicator light beside the "MODE" option will illuminate, identifying the mode selected.

### DRY MODE:

This mode is used to decrease the humidity in the room. Under this mode, you cannot select a fan speed. The fan motor operates at AUTO speed. Keep windows and doors closed for the best dehumidifying effect.

**NOTE:** On the DRY mode, you can not adjust temperature on some models.

### COOL MODE:

The temperature settings are adjustable between 17°C - 30°C. You can select your desired fan speed.

### HEAT MODE: (on some models)

The temperature settings are adjustable between 17°C - 30°C in heating mode. You can select your desired fan speed.

### AUTO MODE:

The fan motor remains on AUTO speed in AUTO mode. The unit will select the appropriate operating mode from FAN, COOL or HEAT (cooling only models without) based upon the temperature difference between the actual and desired room temperature.

**NOTE:** On the AUTO mode, you just can not adjust fan speed.

### FAN MODE:

Press the "MODE" keypad to select the FAN mode, you can press "FAN" keypad to select your desired fan speed but you can not adjust temperature.

## 2.UP AND DOWN buttons

### ▲TEMPERATURE SETTINGS UP:

Press the ▲ keypad to increase the set (operating) temperature of the unit. Each time the keypad is pressed the temperature increases as follows: 1°C (Celsius Scale) Maximum Setting 30°C.

### ▼TEMPERATURE SETTINGS DOWN:

Press the ▼ keypad to decrease the set (operating) temperature of the unit. Each time the keypad is pressed the temperature decreases as follows: 1°C (Celsius Scale) Minimum Setting 17°C.

### 3.FAN

Press this keypad to activate the appropriate fan speed setting. Each depression of the keypad will alternate through AUTO, LOW, MED, HIGH fan speed options.

The indicator light beside the FAN speed option will illuminate, identifying the fan speed selected.

### 4.SWING

Press the "SWING" keypad to activate the automatic air swing feature. The indicator light adjacent to the "SWING" keypad will illuminate, identifying to the selected mode is operational. The vertical louvers will oscillate back and forth (side to side) automatically sweeping air alternately for comfortable cooling/heating. To stop the air swing feature, press the "SWING" keypad again, the indicator light adjacent to the keypad will go off.

### 5.TIMER

- When the unit is on, press the Timer button will initiate the Auto stop program, the TIMER OFF indicator light illuminates. Press the UP or down button to select the desired time. Press the TIMER button again within 10 seconds, the Auto start program is initiated. And the TIMER ON indicator light illuminates. Press the up or down button to select the desired Auto start time.
- When the unit is off, press the Timer button to initiate the Auto start program, press it again within 10 seconds will initiate the Auto stop program.
- Press or hold the UP or DOWN button to change the Auto time by 0.5 hour increments, up to 10 hours, then at 1 hour increments up to 24 hours.
- The control will count down the time remaining until start.
- The system will automatically revert back to display the previous temperature setting if there is no operation in a 10 seconds period.
- Turning the unit ON or OFF at any time or adjusting the timer setting to 0.0 will cancel the Auto Start/Stop timer program.

### 6.SLEEP

Press and hold the "Sleep" function switch on the remote control the "SLEEP" feature. In the Cooling mode, the cooling temperature set point will increase 1°C per hour after the "SLEEP" mode is selected. Two hours later, the set point will continue at this temperature and the fan motor will remain on AUTO speed. In the Heating mode, the heating temperature set point will decrease 1°C per hour after the "SLEEP" mode is selected. Two hours later, the set point will continue at this temperature and the fan motor will remain on AUTO speed. For Inverter Type the new temperature will be maintained for 7 hours, then the unit exits sleep mode and is off. Using the "SLEEP" mode will reduce noise creating a comfortable sleeping environment.

**NOTE:** This feature is not available under DRY and FAN ONLY operation.

### 7.Wireless operation(on some models)

For the first time to use Wireless function, press the SWING button for 3 seconds to initiate the Wireless connection mode. The LED DISPLAY shows 'AP' to indicate you can set Wireless connection. If connection (router) is successful within 8 minutes, the unit will exit Wireless connection mode automatically and the Wireless indicator illuminates. If connection is failure within 8 minutes, the unit exits Wireless connection mode automatically.

## Other features

### LED Display

Displays room temperature on fan only mode, displays the setting temperature on the other modes. Displays times during Timer setting, after 10 seconds, the system will revert back to display the setting temperature.

Shows Error codes(for some units):

Error code appears and begins with the letters as the following in the window display of indoor unit:EH(xx), EL(xx), EC(xx), PH(xx), PL(xx), PC(xx).

**Note:**The unit may stop operation due to a malfunction with the unit. If this occurs, an error code may appear on the display like below. Wait 10 minutes as the problem may resolve itself. If not, disconnect the power, then connect it again. Turn the unit on. If the problem persists, disconnect the power and contact customer service.

Fixed-speed Type

Shows Error codes:

EH60 Indoor room temperature sensor error;

EH61 Evaporator temperature sensor error;

EC52 Outdoor condenser temperature sensor error;

EH00 Indoor EEPROM error;

EH0b Communication error between displayboard and main control;

**Note:** When one of the above malfunctions occurs, turn off the unit, and check for any obstructions. Restart the unit, if the malfunction is still present, turn off the unit and unplug the power cord. Contact the manufacturer or its service agents or a similar qualified person for service.

### Vent Control

The vent control is located above the control knobs. The operation method and the shape may vary in different models (see the following figures)

For maximum cooling efficiency, CLOSE the vent. It will allow internal air circulation. OPEN the vent to discharge stale air.

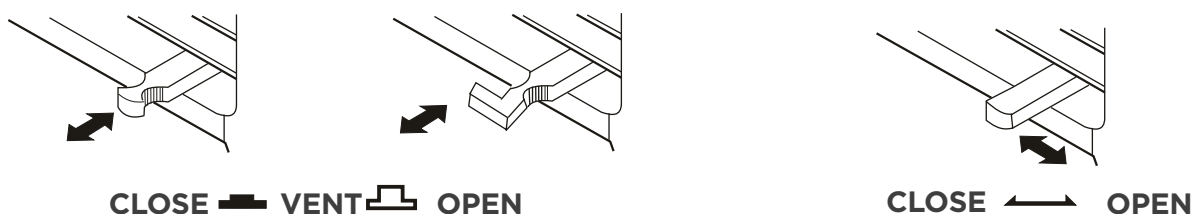

**NOTE:** The vent control is not available for all the units. Some units do not have vent control.

### Air direction control

#### Horizontal airflow adjustment.

- To adjust horizontal airflow direction, use the SWING button on remote control to set the direction of airflow. Please refer to the Remote Control Manual for details. (see Fig. C).

#### Vertical airflow adjustment(Manually)

- When the unit is operating, use the hand to adjust the louvers to change the vertical airflow direction. The vertical angle of air flow can be set by gripping the louver and move to the desired position (see Fig.D). For some units, the connecting rod of the louver is provided with a convex block, it can be moved between the three grooves on the left side of frame at an angle of 0-15 degrees(see Fig.E).

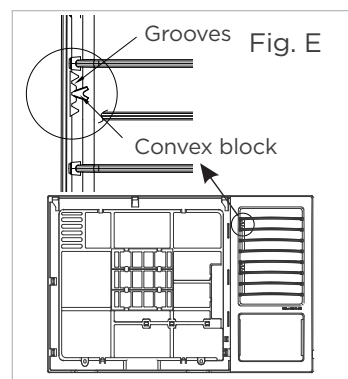
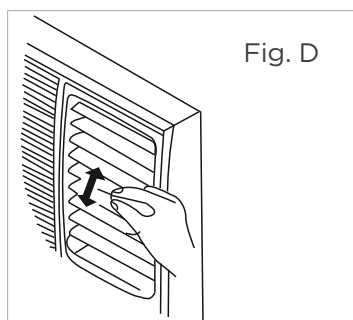
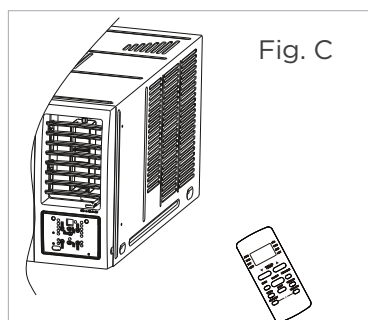

## Water drainage

The condensed water can be treated as follows:

### **Bottom drainage (Applicable for the units designed with bottom drain hole only ).**

- Remove the rubber plug from the bottom of cabinet(if any)
- Take out the drain pan and screws from accessory.
- Fix the drain pan onto the bottom of cabinet by screws.
- Connect an extension drain hose (locally purchased) to the outlet of drain tray.

**NOTE:** The bottom drainage will slightly affect cooling performance, but it can reduce the noise caused by spraying the condensed water. For pump heating, the bottom drainage must be choosed.

### **Back drainage**

- Fit the seal onto the drain joint(provided as accessory).
- Insert the drain joint to the back drainage hole, and rotate it by 90° to be well fitted.
- Connect an extension drain hose (locally purchased according to the installation length request) to the drain joint.
- Make sure to plug the bottom drain hole by rubble plug.

**NOTE:** The back drainage will slightly affect cooling performance, but will reduce the noise caused by spraying the condensed water.

### **Non-drainage**

If you choose non-drainage when cooling, both the bottom and the back drain holes of the unit should be plugged with rubber plugs. The condensed water will be sprayed to condenser, and will improve the cooling performance.

**NOTE:** When you choose non-drainage, the air conditioner will be perfect cooling efficiency, but big noise may be caused by spraying the condensed water. Please do not choose it if you are sensitive to the noise.

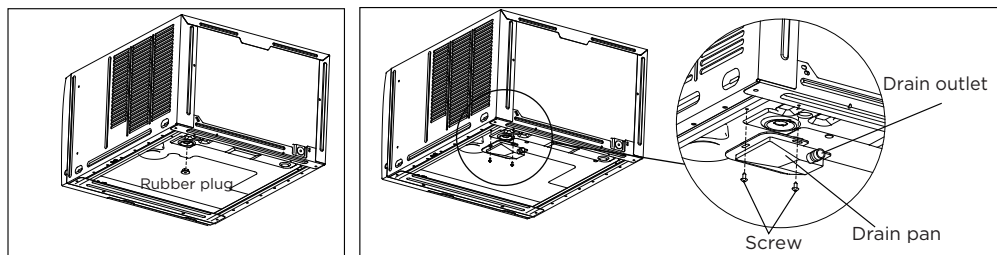

**Bottom drainage**

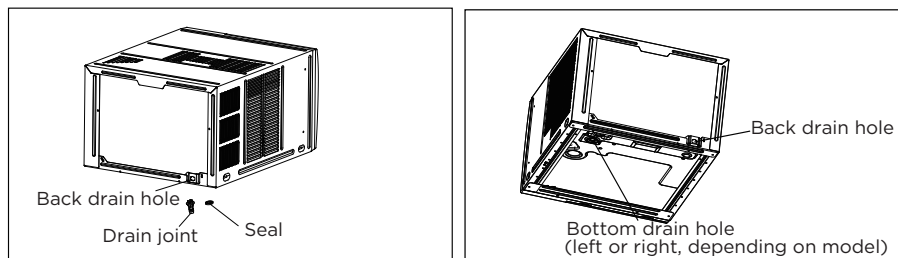

**Back drainage**

**Non-drainage**

### **Note on the product**

- The rated cooling performance is tested under non-drainage status.
- Make sure that water will not leak from the surrounding area when rubber plug and joint were used. Please seal it in case leakage is found.
- For cooling and heating models, the chassis should be drained from the bottom to prevent freezing in winter.

# REMOTE CONTROLLER SPECIFICATIONS

<b>Model</b>	RG51F/EF, RG51F2(1)/EFU1, RG51F4/E, RG51F5(1)/EU1, RG51H(1)/EF, RG51H1(1)/EF, RG51H2(1)/EFU1-M, RG51H3(1)/EU1-M, RG51F6/E, RG51H3(1)/CE-M
<b>Rated Voltage</b>	3.0V( Dry batteries R03/LR03×2)
<b>Signal Receiving Range</b>	8m
<b>Environment</b>	-5°C~60°C(23°F~140°F)

## Quick Start Guide

### 1 FIT BATTERIES

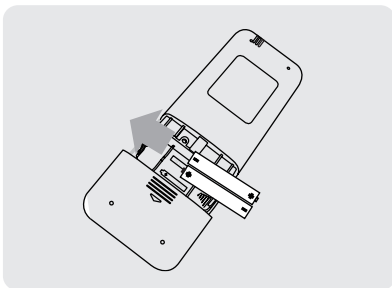

### 2 SELECT MODE

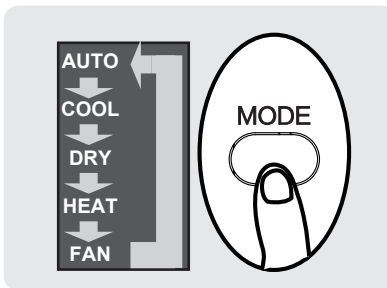

### 3 SELECT TEMPERATURE

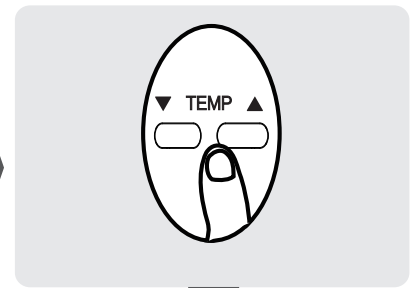

### 6 PRESS POWER BUTTON

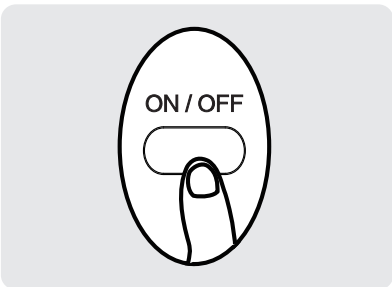

### 5 POINT REMOTE TOWARD UNIT

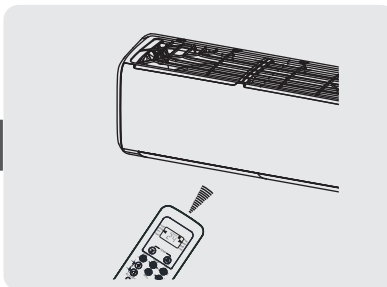

### 4 SELECT FAN SPEED

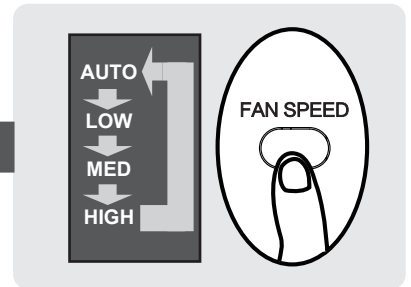

## NOT SURE WHAT A FUNCTION DOES?

Refer to the **How to Use Basic Functions** and **How to Use Advanced Functions** sections of this manual for a detailed description of how to use your air conditioner.

## SPECIAL NOTE

- Button designs on your unit may differ slightly from the example shown.
- If the indoor unit does not have a particular function, pressing that function's button on the remote control will have no effect.
- When there are wide differences between "Remote controller Manual" and "USER'S MANUAL" on function description, the description of "USER'S MANUAL" shall prevail.

# HANDLING THE REMOTE CONTROLLER

## Inserting and Replacing Batteries

Your air conditioning unit may come with two batteries (some units). Put the batteries in the remote control before use.

1. Slide the back cover from the remote control downward, exposing the battery compartment.
2. Insert the batteries, paying attention to match up the (+) and (-) ends of the batteries with the symbols inside the battery compartment.
3. Slide the battery cover back into place.

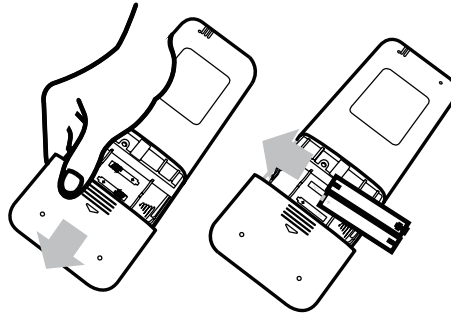

## Remote Control

- Direct sunlight can interfere with the infrared signal receiver.
- There must be a clear line of sight between the remote and the appliance.
- If the signals from the remote control happen to control another appliance, move the appliance to another location or contact customer service.

## ! Battery Disposal

- Do not dispose of batteries as unsorted municipal waste. Refer to local laws for proper disposal of batteries.
- Batteries may have a chemical symbol at the bottom of the disposal icon. This chemical symbol means that the battery contains a heavy metal that exceeds a certain concentration. An example is Pb: Lead (>0.004%).
- Appliances and used batteries must be treated in a specialized facility for reuse, recycling and recovery. By ensuring correct disposal, you will help avoid possible negative consequences for the environment and human health.



## 🔋 Battery Performance

For optimal product performance:

- Do not mix old and new batteries, or batteries of different brands.
- Do not leave batteries in the remote control if you don't plan on using the device for more than 2 months.

## Notes For Using Remote Control

The device could comply with the local national regulations.

- In Canada, it should comply with CAN ICES-3(B)/NMB-3(B).
- In USA, this device complies with part 15 of the FCC Rules. Operation is subject to the following two conditions:
  - (1) This device may not cause harmful interference, and
  - (2) This device must accept any interference received, including interference that may cause undesired operation.

This equipment has been tested and found to comply with the limits for a Class B digital device, pursuant to part 15 of the FCC Rules. These limits are designed to provide reasonable protection against harmful interference in a residential installation. This equipment generates, uses and can radiate radio frequency energy and, if not installed and used in accordance with the instructions, may cause harmful interference to radio communications. However, there is no guarantee that interference will not occur in a particular installation. If this equipment does cause harmful interference to radio or television reception, which can be determined by turning the equipment off and on, the user is encouraged to try to correct the interference by one or more of the following measures:

- Reorient or relocate the receiving antenna.
- Increase the separation between the equipment and receiver.
- Connect the equipment into an outlet on a circuit different from that to which the receiver is connected.
- Consult the dealer or an experienced radio/TV technician for help.
- Changes or modifications not approved by the party responsible for compliance could void user's authority to operate the equipment.

# BUTTONS AND FUNCTIONS

Before you begin using your new air conditioner, make sure to familiarize yourself with its remote control. The following is a brief introduction to the remote control itself. For instructions on how to operate your air conditioner, refer to the **How to Use Basic Functions** section of this manual.

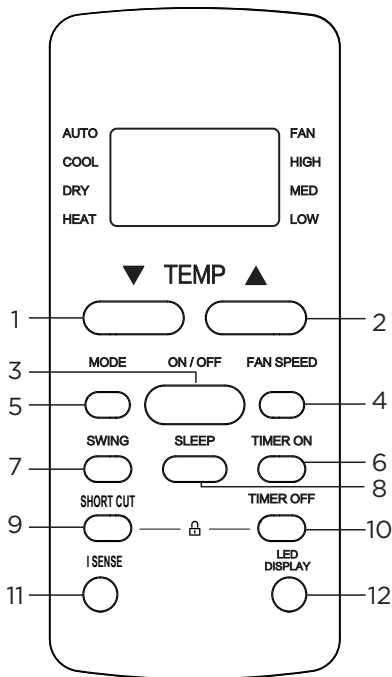

Model: RG51F/EF

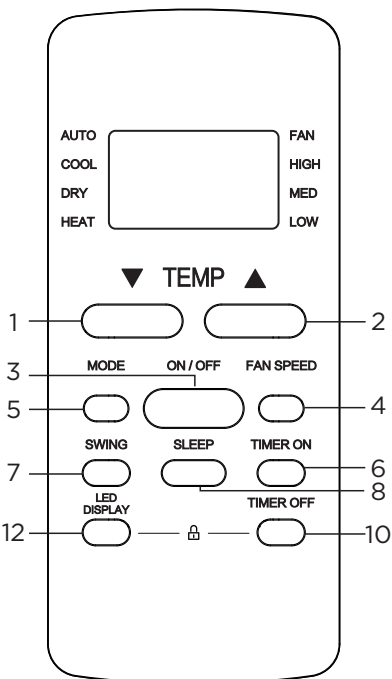

Model: RG51F4/E

Description	
No.1	<b>TEMP ▼</b> Decreases temperature in 1°C increments. Min. temperature is 17°C.
No.2	<b>TEMP ▲</b> Increases temperature in 1°C increments. Max. temperature is 30°C.
No.3	<b>ON/OFF</b> Turns the unit on or off.
No.4	<b>FAN SPEED</b> Selects fan speeds in the following order: AUTO → LOW → MED → HIGH
No.5	<b>MODE</b> Scrolls through operation modes as follows: AUTO → COOL → DRY → HEAT → FAN <b>NOTE:</b> Please do not select HEAT mode if the machine you purchased is cooling only type. Heat mode is not supported by the cooling only appliance.
No.6	<b>TIMER ON</b> Sets timer to turn unit on (see How to Use Basic Functions for instructions).
No.7	<b>SWING</b> Starts and stops the horizontal louver movement. Hold down for 2 seconds to initiate vertical louver auto swing feature(some units).
No.8	<b>SLEEP</b> Saves energy during sleeping hours .
No.9	<b>SHORT CUT</b> Sets and activates your favorite pre-settings
No.10	<b>TIMER OFF</b> Sets timer to turn unit off (see How to Use Basic Functions for instructions).
No.11	<b>I SENSE</b> Temperature sensing and room temperature display button.
No.12	<b>LED DISPLAY</b> Press this button to turn on and turn off the display on the indoor unit.

**NOTE:** Press together the two buttons simultaneously for 5 seconds to lock the keyboard. Press together the two buttons for 2 seconds to unlock the keyboard.



Press together simultaneously

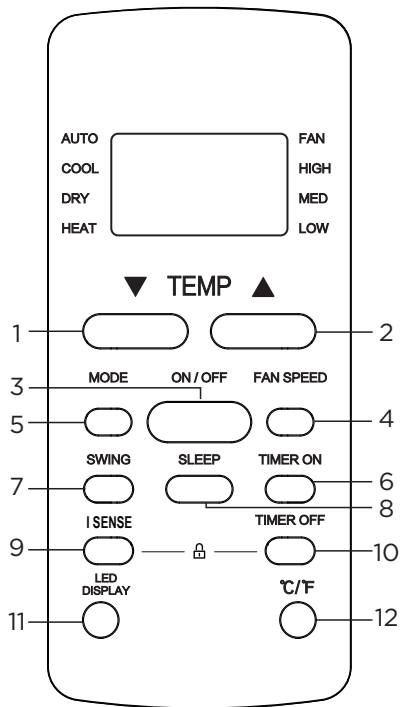

Model: RG51F2(1)/EFU1

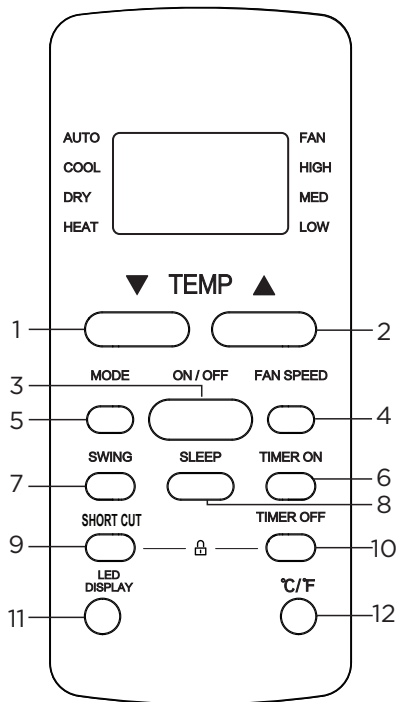

Model: RG51F5(1)/EU1

Description	
No.1	<b>TEMP ▼</b> Decreases temperature in 1°F increments. Min. temperature is 62°F.
No.2	<b>TEMP ▲</b> Increases temperature in 1°F increments. Max. temperature is 86°F.
No.3	<b>ON/OFF</b> Turns the unit on or off.
No.4	<b>FAN SPEED</b> Selects fan speeds in the following order: AUTO → LOW → MED → HIGH
No.5	<b>MODE</b> Scrolls through operation modes as follows: AUTO → COOL → DRY → HEAT → FAN <b>NOTE:</b> Please do not select HEAT mode if the machine you purchased is cooling only type. Heat mode is not supported by the cooling only appliance.
No.6	<b>TIMER ON</b> Sets timer to turn unit on (see How to Use Basic Functions for instructions).
No.7	<b>SWING</b> Starts and stops the horizontal louver movement. Hold down for 2 seconds to initiate vertical louver auto swing feature(some units).
No.8	<b>SLEEP</b> Saves energy during sleeping hours .
No.9	<b>I SENSE</b> Temperature sensing and room temperature display button. <b>SHORT CUT</b> Sets and activates your favorite pre-settings
No.10	<b>TIMER OFF</b> Sets timer to turn unit off (see How to Use Basic Functions for instructions).
No.11	<b>LED DISPLAY</b> Press this button to turn on and turn off the display on the indoor unit.
No.12	<b>°C/°F</b> Press this button to alternate the temperature display between the °C & °F.

**NOTE:** Press together the two buttons simultaneously for 5 seconds to lock the keyboard. Press together the two buttons for 2 seconds to unlock the keyboard.

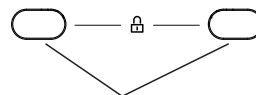

Press together simultaneously

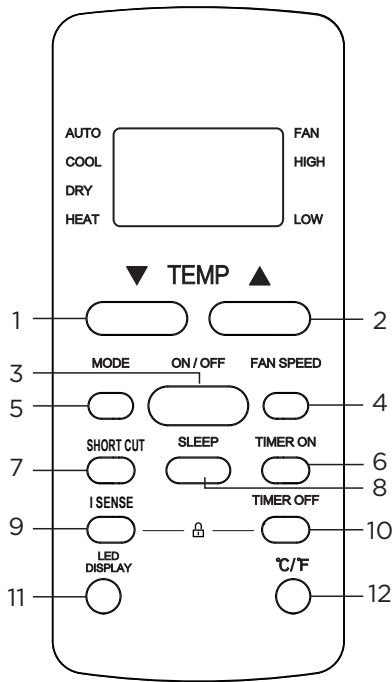

Model: RG51H2(1)/EFU1-M

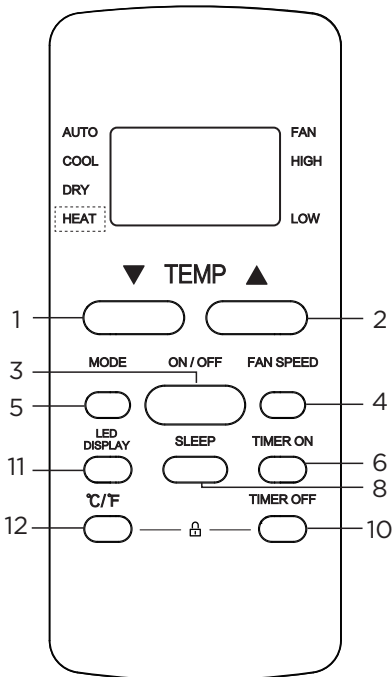

Model:  
RG51H3(1)/EU1-M  
RG51H3(1)/CE-M  
(Cooling only model, HEAT mode  
is not available)

Description	
No.1	<b>TEMP ▼</b> Decreases temperate in 1°C/1°F increments. Min. temperature is 17°C/62°F.
No.2	<b>TEMP ▲</b> Increases temperate in 1°C/1°F increments. Max. temperature is 30°C/86°F.
No.3	<b>ON/OFF</b> Turns the unit on or off.
No.4	<b>FAN SPEED</b> Selects fan speeds in the following order: AUTO → LOW → HIGH
No.5	<b>MODE</b> Scrolls through operation modes as follows: AUTO → COOL → DRY → HEAT (cooling models without) → FAN <b>NOTE:</b> Please do not select HEAT mode if the machine you purchased is cooling only type. Heat mode is not supported by the cooling only appliance.
No.6	<b>TIMER ON</b> Sets timer to turn unit on (see How to Use Basic Functions for instructions).
No.7	<b>SHORT CUT</b> Sets and activates your favorite pre-settings
No.8	<b>SLEEP</b> Saves energy during sleeping hours .
No.9	<b>I SENSE</b> Temperature sensing and room temperature display button.
No.10	<b>TIMER OFF</b> Sets timer to turn unit off (see How to Use Basic Functions for instructions).
No.11	<b>LED DISPLAY</b> Press this button to turn on and turn off the display on the indoor unit.
No.12	<b>°C/°F</b> Press this button to alternate the temperature display between the °C & °F.

**NOTE:** Press together the two buttons simultaneously for 5 seconds to lock the keyboard. Press together the two buttons for 2 seconds to unlock the keyboard.

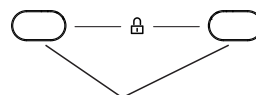

Press together simultaneously

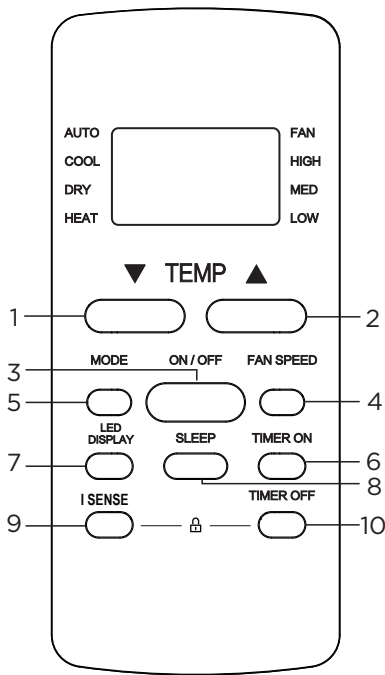

Model: RG51H(1)/EF

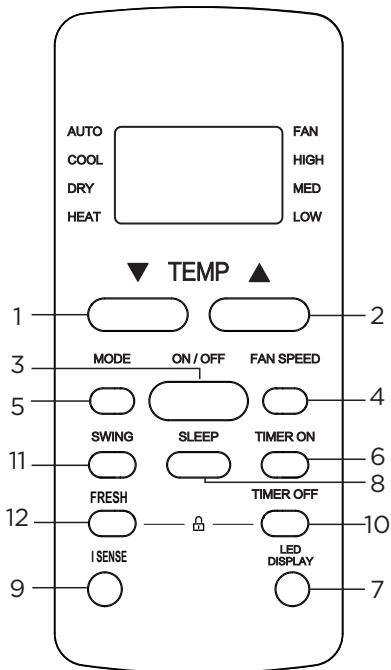

Model: RG51H1(1)/EF

## Description

No.1	<b>TEMP ▼</b> Decreases temperature in 1°C increments. Min. temperature is 17°C.
No.2	<b>TEMP ▲</b> Increases temperature in 1°C increments. Max. temperature is 30°C. <b>NOTE:</b> Press together ▼ & ▲ buttons at the same time for 3 seconds will alternate the temperature display between the °C & °F.
No.3	<b>ON/OFF</b> Turns the unit on or off.
No.4	<b>FAN SPEED</b> Selects fan speeds in the following order: AUTO → LOW → MED → HIGH
No.5	<b>MODE</b> Scrolls through operation modes as follows: AUTO → COOL → DRY → HEAT → FAN <b>NOTE:</b> Please do not select HEAT mode if the machine you purchased is cooling only type. Heat mode is not supported by the cooling only appliance.
No.6	<b>TIMER ON</b> Sets timer to turn unit on (see How to Use Basic Functions for instructions).
No.7	<b>LED DISPLAY</b> Press this button to turn on and turn off the display on the indoor unit.
No.8	<b>SLEEP</b> Saves energy during sleeping hours .
No.9	<b>I SENSE</b> Temperature sensing and room temperature display button.
No.10	<b>TIMER OFF</b> Sets timer to turn unit off (see How to Use Basic Functions for instructions).
No.11	<b>SWING</b> Starts and stops the horizontal louver movement. Hold down for 2 seconds to initiate vertical louver auto swing feature(some units).
No.12	<b>FRESH</b> Starts and stops the Fresh feature. It will help to purify the air in the room.

**NOTE:** Press together the two buttons simultaneously for 5 seconds to lock the keyboard. Press together the two buttons for 2 seconds to unlock the keyboard.

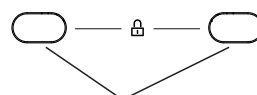

Press together simultaneously

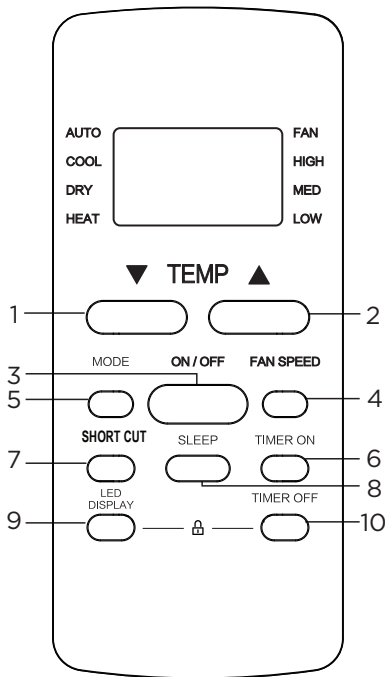

Model: RG51F6/E

Description	
No.1	<b>TEMP ▼</b> Decreases temperature in 1°C increments. Min. temperature is 17°C.
No.2	<b>TEMP ▲</b> Increases temperature in 1°C increments. Max. temperature is 30°C.
No.3	<b>ON/OFF</b> Turns the unit on or off.
No.4	<b>FAN SPEED</b> Selects fan speeds in the following order: AUTO → LOW → MED → HIGH
No.5	<b>MODE</b> Scrolls through operation modes as follows: AUTO → COOL → DRY → HEAT → FAN <b>NOTE:</b> Please do not select HEAT mode if the machine you purchased is cooling only type. Heat mode is not supported by the cooling only appliance.
No.6	<b>TIMER ON</b> Sets timer to turn unit on (see How to Use Basic Functions for instructions).
No.7	<b>SHORT CUT</b> Sets and activates your favorite pre-settings.
No.8	<b>SLEEP</b> Saves energy during sleeping hours .
No.9	<b>LED DISPLAY</b> Press this button to turn on and turn off the display on the indoor unit.
No.10	<b>TIMER OFF</b> Sets timer to turn unit off (see How to Use Basic Functions for instructions).

**NOTE:** Press together the two buttons simultaneously for 5 seconds to lock the keyboard. Press together the two buttons for 2 seconds to unlock the keyboard.

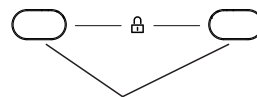







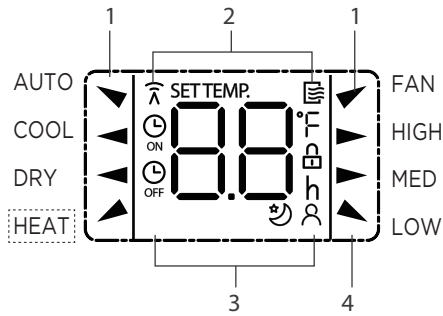



Press together simultaneously

# REMOTE SCREEN INDICATORS

Information are displayed when the remote controller is power up.



No.1	Mode display AUTO ▼ COOL ◀ DRY ◀ ▼ FAN HEAT ▲ (some units)
No.2	 Displayed when data transmitted.  Displayed when remote controller is ON.
No.3	 Displayed when TIMER ON time is set.  Displayed when TIMER OFF time is set.  Shows set temperature or room temperature, or time under TIMER setting.  Indicated all the current settings are locked.  Displayed when I SENSE feature is activated. (some units)  Displayed when SLEEP feature is activated.
No.4	FAN SPEED indication  HIGH High speed  MED Medium speed(some units)  LOW Low speed NO display Auto fan speed

## Note:

All indicators shown in the figure are for the purpose of clear presentation. But during the actual operation, only the relative function signs are shown on the display window.

# HOW TO USE BASIC FUNCTIONS

**ATTENTION!** Before operation, please ensure the unit is plugged in and power is available.

## AUTO Mode

Select AUTO mode

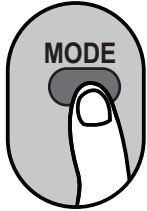

Set your desired temperature



Turn on the air conditioner



### NOTE:

1. In AUTO mode, the unit will automatically select the COOL, FAN, or HEAT function based on the set temperature.
2. In AUTO mode, fan speed can not be set.

## COOL or HEAT Mode

Select COOL/HEAT mode

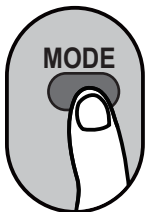

Set the temperature

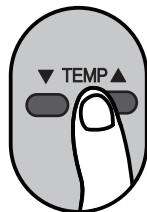

Set the fan speed



Turn on the air conditioner



## DRY Mode

Select DRY mode

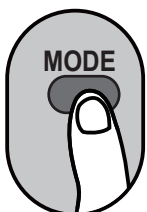

Set your desired temperature

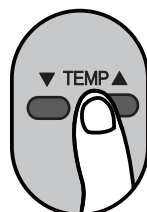

Turn on the air conditioner



**NOTE:** In DRY mode, fan speed can not be set since it has already been automatically controlled.

## FAN Mode

Select FAN mode

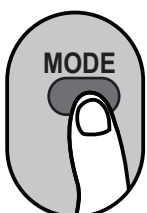

Set the fan speed



Turn on the air conditioner



**NOTE:** In FAN mode, you can't set the temperature. As a result, no temperature displays in remote screen.

## Setting the TIMER

TIMER ON/OFF - Set the amount of time after which the unit will automatically turn on/off.

### TIMER ON setting

Press TIMER ON button to initiate the ON time sequence.



Press Temp. up or down button for multiple times to set the desired time to turn on the unit.

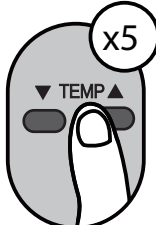

Point remote to unit and wait 1sec, the TIMER ON will be activated.



### TIMER OFF setting

Press TIMER OFF button to initiate the OFF time sequence.



Press Temp. up or down button for multiple times to set the desired time to turn off the unit.

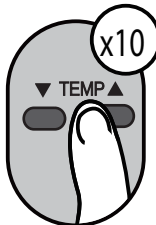

Point remote to unit and wait 1sec, the TIMER OFF will be activated.



### NOTE

1. When setting the TIMER ON or TIMER OFF, the time will increase by 30 minutes increments with each press, up to 10 hours. After 10 hours and up to 24, it will increase in 1 hour increments. (For example, press 5 times to get 2.5h, and press 10 times to get 5h). The timer will revert to 0.0 after 24.
2. Cancel either function by setting its timer to 0.0h.

### TIMER ON & OFF setting(example)

Keep in mind that the time periods you set for both functions refer to hours after the current time.

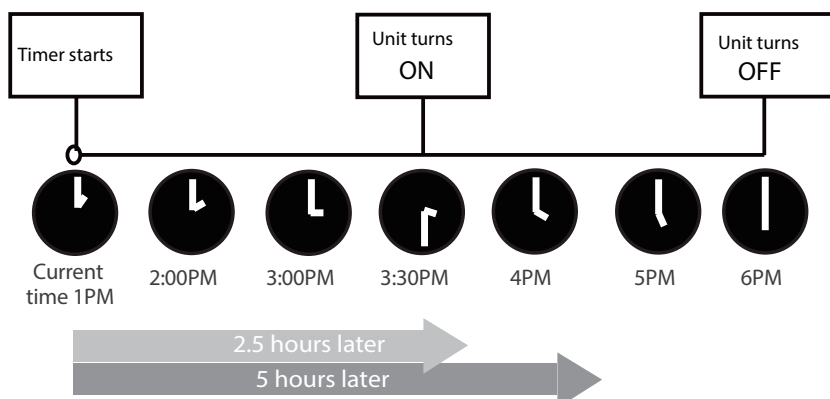
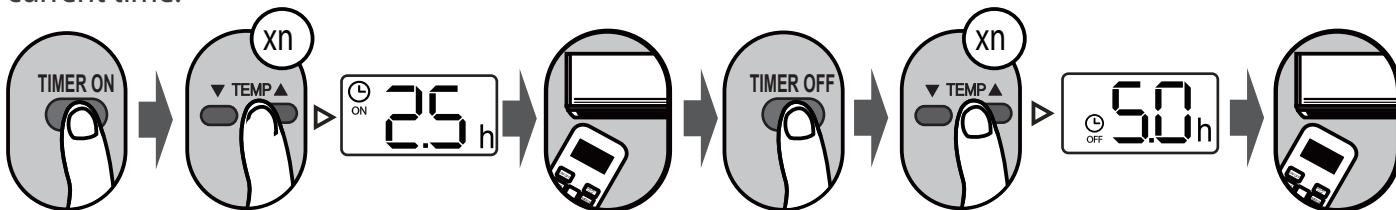

**Example:** If current timer is 1:00PM, to set the timer as above steps, the unit will turn on 2.5h later (3:30PM) and turn off at 6:00PM.

# HOW TO USE ADVANCED FUNCTIONS

## Swing function(some units)

Press Swing button

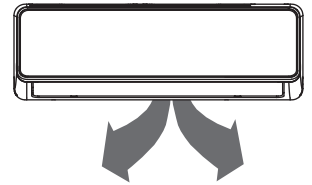
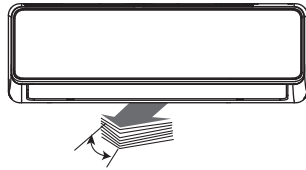
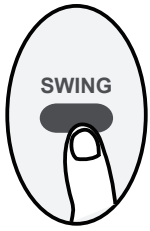

The horizontal louver will swing up and down automatically when pressing Swing button. Press again to make it stop.

Keep pressing this button more than 2 seconds, the vertical louver swing function is activated. (Model dependent)

## SLEEP function

The SLEEP function is used to decrease energy use while you sleep (and don't need the same temperature settings to stay comfortable). This function can only be activated via remote control. The sleep function is not available in Fan or Dry mode. Please refer to the OWNER'S MANUAL for more details.



## I SENSE function(some units)

When the I SENSE function is activated, the remote display is actual temperature at its location. The remote control will send this signal to the air conditioner every 3 minutes interval until press the I SENSE button again.

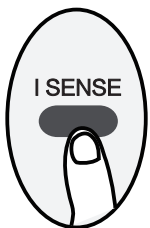

## NOTE

- Press this button for seven seconds to start/stop memory feature of I SENSE function.
- If the memory feature is activated, " **On** " displays for 3 seconds on the screen.
- If the memory feature is stopped, " **OF** " displays for 3 seconds on the screen.
- While the memory feature is activated, press the ON/OFF button, shift the mode or power failure will not cancel the I SENSE function.

## SHORT CUT function(some units)

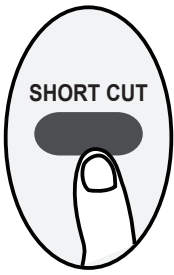

Used to restore the current settings or resume previous settings.

Push this button when remote controller is on, the system will automatically revert back to the previous settings including operating mode, setting temperature, fan speed level and sleep feature(if activated).

If pushing more than 2 seconds, the system will automatically restore the current operation settings including operating mode, setting temperature, fan speed level and sleep feature(if activated).

## FP function

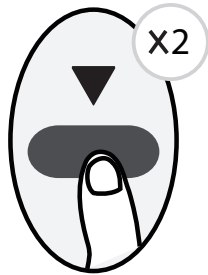

The unit will operate at high fan speed (while compressor on) with temperature automatically set to 8 °C/46 °F.

Note: This function is for heat pump air conditioner only.

Press this button 2 times during one second under HEAT Mode and setting temperature of 17 °C/62 °F to activate FP function.

Press On/Off, Sleep, Mode, Fan and Temp. button while operating will cancel this function.

# CARE AND MAINTENANCE

## ⚠ CAUTION

- **ALWAYS TURN OFF YOUR AIR CONDITIONER SYSTEM AND DISCONNECT ITS POWER SUPPLY BEFORE CLEANING OR MAINTENANCE.**
- The cabinet and front panel may be dusted with an oil-free cloth or washed with a cloth dampened in a solution of warm water and mild liquid dishwashing detergent. Wash and dry.
- Do not use inflammable sprays such as lacquer or hair spray near the air conditioner
- Do not use benzene, alcohol, gasoline, acid, paint thinner, polishing powder or other solvents to clean the unit. The unit can be damaged.
- Do not use water hotter than 50°C (122°F) to clean the front panel. This can cause the panel to deform or become discolored.  
Excess water in or around the controls may cause damage to the air conditioner. Be sure to wring excess water from the cloth before wipe it clean.

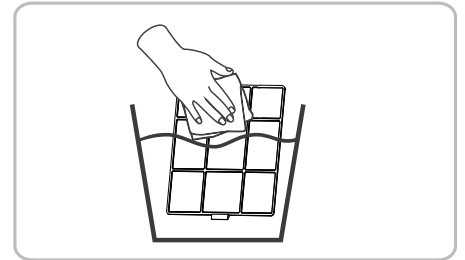
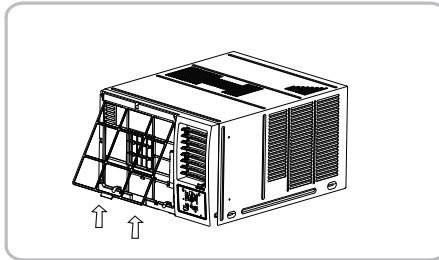
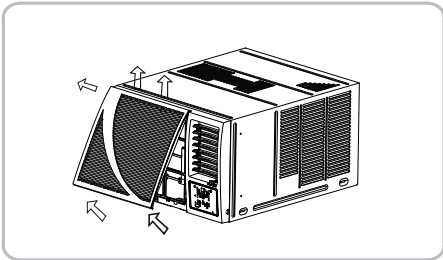

If your filter has a small air freshening filter (optional), it can be installed at any of the three positions, install it at the position as you like. Clean it with a hand-held vacuum.

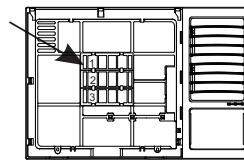

## Cleaning Your Air Filter

A clogged air filter can reduce the cooling efficiency of your unit and increase operating noise. Make sure to clean the filter once every two weeks (or as necessary) during periods of frequent operation.

1. Hold the slot under the front panel, then uplift it outwards, and remove the front panel.
2. Pinch the handle under the air filter and make the air filter arched, remove it from the slot from underside to upside.
3. Clean the filter with warm, soapy water. The water should be below 40°C (104°F) to prevent distortion of the filter.

## ⚠ CAUTION

**NEVER** operate the air conditioner without the air filter, as dust/dirt particles can contribute to equipment failure.

## Winter Storage

If you plan to store the air conditioner during the winter, remove it carefully from the window according to the installation instructions. Be careful not to spill any potentially standing water from the unit's base pan. If water is present, carefully drain it. Cover the unit with plastic or return it to the original carton.

# TROUBLESHOOTING

## **⚠ SAFETY PRECAUTIONS**

If ANY of the following conditions occurs, turn off your unit immediately!

- The power cord is damaged or abnormally warm
- You smell a burning odor
- The unit emits loud or abnormal sounds
- A power fuse blows or the circuit breaker frequently trips
- Water or other objects fall into or out of the unit

**DO NOT ATTEMPT TO FIX THESE YOURSELF! CONTACT AN AUTHORIZED SERVICE PROVIDER IMMEDIATELY!**

## Common Issues

The following problems are not a malfunction and in most situations will not require repairs.

Issue	Possible Causes
<b>Unit does not turn on when pressing ON/OFF button</b>	Wall plug disconnected. Push plug firmly into wall outlet.
	House fuse blown or circuit breaker tripped. Replace fuse with time delay type or reset circuit breaker.
	Selector Control in OFF position. Turn selector to the desired FAN or COOL setting.
	Unit turned off by moving thermostat to a higher number and then immediately turning back to a colder number. Wait approximately 3 minutes. Listen for compressor to start.
	Unit turned off and then on too quickly. Turn unit off and wait for 3 minutes before restarting.
	Thermostat set too low. Adjust thermostat to higher number for cooling.
<b>Air from unit does not feel cold enough</b>	Turn selector to a higher COOL position.
	Thermostat set too warm. Set thermostat to colder temperature.
	Room temperature below 18°C(64°F). Cooling may not occur until room temperature rise above 18°C(64°F).
	Temperature sensing tube touching cold coil, located behind air filter. Straighten tube away from coil. Outdoor temperature below 18°C(64°F). To defrost the coil, set selector to FAN position. Then, set thermostat to warmer position.
<b>Air conditioner cooling, but room is too warm- ice forming on cooling coil behind decorative front</b>	Air filter may be dirty. Clean filter. Refer to Care and Maintenance section. To defrost, set selector to FAN.
	Thermostat set too cold for night-time cooling. To defrost the coil, set selector to a FAN position. Then, set thermostat to a warmer position.
	Dirty air filter- air restricted. Clean air filter. Refer to Care and Maintenance section.
	Thermostat set too warm. Turn thermostat clockwise to a colder setting.
	All directional louvers positioned improperly. Position louvers for better air distribution.
	Front of units is blocked by drapes, blinds, furniture, etc. - restricts air distribution. Clear blockage in front of unit.
	Doors, windows, registers, etc. Open- cold air escapes. Close doors, windows, registers.
Unit recently turned on in hot room. Allow additional time to remove "Stored heat" from walls, ceiling, floor and furniture. Dirty air filter - air restricted. Clean air filter.	
<b>Air conditioner turns on and off rapidly</b>	Outside temperature extremely hot. Set to high cool to bring air past cooling coils more frequently. Air movement sound. This is normal. If too loud, turn selector to lower FAN setting.
<b>Noise when unit is cooling</b>	Sound of fan hitting water-moisture removal system. This is normal when humidity is high. Close doors, windows and registers.
<b>Water dripping INSIDE when unit is cooling</b>	Window vibration - poor installation. Refer to installation instructions or check with installer. Improper installation. Tilt air conditioner slightly to the outside to allow water drainage. Refer to installation instructions - check with installer.
<b>Water dripping OUTSIDE when unit is cooling</b>	Unit removing large quantity of moisture from humid room. This is normal during excessively humid days.

# SPECIFICATIONS

## Unit dimensions:

MODEL(But/h)	BODY DIMENSION(WxHxD)(mm)
5000-6000	445x320x415
	450x346x535
7000-9000	450x346x535
	450x346x585
	560x375x695
9000-12000	450x346x585
	560x400x640
	600x380x560
	560x375x695
15000-24000	660x428x680
	660x428x780

**NOTE:** For the different customization requirements, the depth of the panel may be slightly different. So the dimension of “D” is for reference only.

## Choose the right cable size

The size of the power supply cable, signal cable, fuse, and switch needed is determined by the maximum current of the unit. The maximum current is indicated on the nameplate located on the side panel of the unit. Refer to this nameplate to choose the right cable, fuse, or switch.

### Minimum nominal cross-sectional area of conductors:

Rated Current of Appliance (A)	Nominal Cross-Sectional Area (mm <sup>2</sup> )
> 3 and ≤ 6	0.75
> 6 and ≤ 10	1
> 10 and ≤ 16	1.5
> 16 and ≤ 25	2.5
> 25 and ≤ 32	4
> 32 and ≤ 40	6

**NOTE:** TO be in compliance EN61000-3-11, the product MWT2F-21CM-QB4 shall be connected only to a supply of the system impedance:  $|Z_{sys}|=0.156$  ohms or less; the product MWT2F1-22CM-QB4 shall be connected only to a supply of the system impedance:  $|Z_{sys}|=0.132$  ohms or less; the product MWT2F1-22CM-QB8 shall be connected only to a supply of the system impedance:  $|Z_{sys}|=0.077$  ohms or less. Before connect the product to public power network, please consult your local power supply authority to ensure the power network meet above requirement.

## Packing and unpacking the unit

Instructions for packing / unpacking the unit:

Unpacking:

1. Cut the packing belt and sealing tape on the carton with a knife.
2. Remove the carton.
3. Remove the left and right package foam or the upper and lower packaging foam, and take out the accessory package if it is included.
4. Untie the packaging bag.
5. Take out the unit.

Packing:

1. Put the unit into the packing bag.
2. Attach the left and right package foam or the upper and lower packaging foam to the unit.
3. Put the unit into the carton, then put accessory package in.
4. Seal carton with the tape.
5. Using the packing belt if necessary.

**NOTE:** Please keep all packaging items if you may need in the future

# TRADEMARKS, COPYRIGHTS AND LEGAL STATEMENT

 Midea logo, word marks, trade name, trade dress and all versions thereof are valuable assets of Midea Group and/or its affiliates (“Midea”), to which Midea owns trademarks, copyrights and other intellectual property rights, and all goodwill derived from using any part of an Midea trademark. Use of Midea trademark for commercial purposes without the prior written consent of Midea may constitute trademark infringement or unfair competition in violation of relevant laws.

This manual is created by Midea and Midea reserves all copyrights thereof. No entity or individual may use, duplicate, modify, distribute in whole or in part this manual, or bundle or sell with other products without the prior written consent of Midea.

All the described functions and instructions were up to date at the time of printing this manual. However, the actual product may vary due to improved functions and designs.

## DISPOSAL AND RECYCLING

### **Important instructions for environment(European Disposal Guidelines)**

Compliance with the WEEE Directive and Disposing of the Waster Product:  
This product complies with EU WEEE Directive. This product bears a classification symbol for waster electrical and electronic equipment (WEEE).

This symbol indicates that this product shall not be disposed with other household wastes at the end of its service life. Used device must be returned to official collection point for recycling of electrical electronic devices. To find these collection systems please contact to your local authorities or retailer where the product was purchased. Each household performs important role in recovering and recycling of old appliance. Appropriate disposal of used appliance helps prevent potential negative consequences for the environment and human health.



# DATA PROTECTION NOTICE

For the provision of the services agreed with the customer, we agree to comply without restriction with all stipulations of applicable data protection law, in line with agreed countries within which services to the customer will be delivered, as well as, where applicable, the EU General Data Protection Regulation (GDPR).

Generally, our data processing is to fulfil our obligation under contract with you and for product safety reasons, to safeguard your rights in connection with warranty and product registration questions. In some cases, but only if appropriate data protection is ensured, personal data might be transferred to recipients located outside of the European Economic Area.

Further information are provided on request. You can contact our Data Protection Officer via **MideaDPO@midea.com**. To exercise your rights such as right to object your personal data being processed for direct marketing purposes, please contact us via **MideaDPO@midea.com**. To find further information, please follow the QR Code.

The design and specifications are subject to change without prior notice for product improvement. Consult with the sales agency or manufacturer for details. Any updates to the manual will be uploaded to the service website, please check for the latest version.

The product meets the requirements of Cyber Security (Security Standards for Smart Devices) Rules 2025. Find the Statement of Compliance in these website: <https://www.midea.com/au/support/statement-of-compliance>

Importer: MIDEA AIR CONDITIONING AUSTRALIA

Manufacturer: GD Midea Air-Conditioning Equipment Co.,Ltd.  
Lingang Road Beijiao Shunde Foshan Guangdong  
People's Republic of China 528311



*make yourself at home*



<https://www.midea.com/au>  
<https://www.mdhome.com.au>  
© Midea 2022 all rights reserved

CW005UI-F(E)MN1  
16120300A33852  
20240904