

PORTABLE AIR CONDITIONER(Local Air Conditioner)

USER MANUAL

**MPPD30C
MPPD33H
MPPD40C**



Warning notices: Before using this product, please read this manual carefully and keep it for future reference. The design and specifications are subject to change without prior notice for product improvement. Consult with your dealer or manufacturer for details. The diagram above is just for reference. Please take the appearance of the actual product as the standard.

THANK YOU LETTER

Thank you for choosing Midea! Before using your new Midea product, please read this manual thoroughly to ensure that you know how to operate the features and functions that your new appliance offers in a safe way.

CONTENTS

THANK YOU LETTER	01
SAFETY PRECAUTIONS	02
SPECIFICATIONS	11
PRODUCT OVERVIEW	12
CONFIRM IT BEFORE YOU GET START	13
PRODUCT INSTALLATION	15
OPERATION INSTRUCTIONS	20
Control Panel	20
Water drainage	24
Remote Control Operation	25
CLEANING AND MAINTENANCE	36
TROUBLESHOOTING	38
TRADEMARKS, COPYRIGHTS AND LEGAL STATEMENT	39
DISPOSAL AND RECYCLING	39
DATA PROTECTION NOTICE	40

SAFETY PRECAUTIONS

It's really important you read Safety Precautions Before Operation and Installation. Incorrect installation due to ignoring instructions can cause serious damage or injury. The seriousness of potential damage or injuries is classified as either a **WARNING** or **CAUTION**.

Explanation of Symbols



WARNING

The signal word indicates a hazard with a medium level of risk which, if not avoided, may result in death or serious injury.



CAUTION

The signal word indicates a hazard with a low degree of risk which, if not avoided, may result in minor or moderate injury.

Read these operating instructions carefully and attentively before using/commissioning the unit and keep them in the immediate vicinity of the installation site or unit for later use!

WARNING

- Installation must be performed according to the installation instructions. Improper installation can cause water leakage, electrical shock, or fire.
- Use only the included accessories and parts, and specified tools for the installation. Using non-standard parts can cause water leakage, electrical shock, fire, and injury or property damage.
- Make sure that the outlet you are using is grounded and has the appropriate voltage. The power cord is equipped with a three-prong grounding plug to protect against shock. Voltage information can be found on the nameplate of the unit.
- Your unit must be used in a properly grounded wall receptacle. If the wall receptacle you intend to use is not adequately grounded or protected by a time delay fuse or circuit breaker (the fuse or circuit breaker needed is determined by the maximum current of the unit. The maximum current is indicated on the nameplate located on unit), have a qualified electrician install the proper receptacle.
- Install the unit on a flat, sturdy surface. Failure to do so could result in damage or excessive noise and vibration.
- The unit must be kept free from obstruction to ensure proper function and to mitigate safety hazards.

WARNING

- Do not modify the length of the power cord or use an extension cord to power the unit.
- Do not share a single outlet with other electrical appliances. Improper power supply can cause fire or electrical shock.
- Do not install your air conditioner in a wet room such as a bathroom or laundry room. Too much exposure to water can cause electrical components to short circuit.
- Do not install the unit in a location that may be exposed to combustible gas, as this could cause fire.
The unit has wheels to facilitate moving. Make sure not to use the wheels on thick carpet or to roll over objects, as these could cause tipping.
- Do not operate a unit that it has been dropped or damaged.
- The appliance with electric heater shall have at least 1 meter space to the combustible materials.
- Do not touch the unit with wet or damp hands or when barefoot.
- If the air conditioner is knocked over during use, turn off the unit and unplug it from the main power supply immediately. Visually inspect the unit to ensure there is no damage. If you suspect the unit has been damaged, contact a technician or customer service for assistance.
- In a thunderstorm, the power must be cut off to avoid damage to the machine due to lightning.
- Your air conditioner should be used in such a way that it is protected from moisture. e.g. condensation, splashed water, etc. Do not place or store your air conditioner where it can fall or be pulled into water or any other liquid. Unplug immediately if it occurs.
- All wiring must be performed strictly in accordance with the wiring diagram located inside of the unit.
- The unit's circuit board(PCB) is designed with a fuse to provide overcurrent protection. The specifications of the fuse are printed on the circuit board, such as: T 3.15A/250V, etc.
- When the water drainage function is not in use, keep the upper and the lower drain plug firmly to the unit to get rid of choking. When the drain plug is not in use, keep it carefully to prevent children from choking.

CAUTION

- This appliance can be used by children aged from 8 years and above and person with reduced physical, sensory or mental capabilities or lack of experience and knowledge if they have been given supervision or instruction concerning use of the appliance in a safe way and understand the hazards involved. Children shall not play with the appliance. Cleaning and user maintenance shall not be made by children without supervision (be applicable for the European Countries).
- This appliance is not intended for use by persons (including children) with reduced physical, sensory or mental capabilities or lack of experience and knowledge, unless they have been given supervision or instruction concerning use of the appliance by a person responsible for their safety. Children should be supervised to ensure that they do not play with the appliance. Children must be supervised around the unit at all times (be applicable for other countries except the European Countries).
- If the supply cord is damaged, it must be replaced by the manufacturer, its service agent or similarly qualified persons in order to avoid a hazard.

CAUTION

- Prior to cleaning or other maintenance, the appliance must be disconnected from the supply mains.
- Do not remove any fixed covers. Never use this appliance if it is not working properly, or if it has been dropped or damaged.
- Do not run cord under carpeting. Do not cover cord with throw rugs, runners, or similar coverings. Do not route cord under furniture or appliances. Arrange cord away from traffic area and where it will not be tripped over.
- Do not operate unit with a damaged cord, plug, power fuse or circuit breaker. Discard unit or return to an authorized service facility for examination and/or repair.
- To reduce the risk of fire or electric shock, do not use this fan with any solid-state speed control device.
- The appliance shall be installed in accordance with national wiring regulations.
- Contact the authorised service technician for repair or maintenance of this unit.
- Contact the authorised installer for installation of this unit.
- Do not cover or obstruct the inlet or outlet grilles.
- Do not use this product for functions other than those described in this instruction manual.
- Before cleaning, turn off the power and unplug the unit.
- Disconnect the power if strange sounds, smell, or smoke comes from it.
- Do not press the buttons on the control panel with anything other than your fingers.
- Do not remove any fixed covers. Never use this appliance if it is not working properly, or if it has been dropped or damaged.
- Do not operate or stop the unit by inserting or pulling out the power cord plug.
- Do not use hazardous chemicals to clean or come into contact with the unit. Do not use the unit in the presence of inflammable substances or vapour such as alcohol, insecticides, petrol, etc.
- Always transport your air conditioner in a vertical position and stand on a stable, level surface during use.
- Always contact a qualified person to carry out repairs. If the damaged power supply cord must be replaced with a new power supply cord obtained from the product manufacturer and not repaired.
- Hold the plug by the head of the power plug when taking it out.
- Turn off the product when not in use.

Note about Fluorinated Gasses(Not applicable to the unit using R290 Refrigerant)

1. Fluorinated greenhouse gases are contained in hermetically sealed equipment. For specific information on the type, the amount and the CO₂ equivalent in tonnes of the fluorinated greenhouse gas (on some models), please refer to the relevant label on the unit itself.
2. Installation, service, maintenance and repair of this unit must be performed by a certified technician.
3. Product uninstallation and recycling must be performed by a certified technician.

⚠ WARNING for Using R32/R290 Refrigerant

- Do not use means to accelerate the defrosting process or to clean, other than those recommended by the manufacturer.
- The appliance shall be stored in a room without continuously operating ignition sources (for example: open flames, an operating gas appliance or an operating electric heater).
- Do not pierce or burn.
- Be aware that the refrigerants may not contain an odour.
- Appliance should be installed, operated and stored in a room with a floor area according to the amount of refrigerant to be charged. For specific information on the type of gas and the amount, please refer to the relevant label on the unit itself. When there are differences between the label and the manual on the Min. room area description, the description on label shall prevail.

For R290(Not applicable for North America)

amount of refrigerant (kg)	Min. room area(m²)	amount of refrigerant (kg)	Min. room area(m²)
≤ 0.0836	4	> 0.1881 and ≤ 0.2090	10
>0.0836 and ≤0.1045	5	>0.2090 and ≤0.2299	11
>0.1045 and ≤ 0.1254	6	>0.2299 and ≤ 0.2508	12
>0.1254 and ≤ 0.1463	7	>0.2508 and ≤ 0.2717	13
>0.1463 and ≤ 0.1672	8	>0.2717 and ≤ 0.2926	14
>0.1672 and ≤ 0.1881	9	>0.2926 and ≤ 0.3040	15

For R32 frigerant models:





Appliance shall be installed, operated and stored in a room with a floor area larger than 4 m². Appliance shall not be installed in an unventilated space.

- Compliance with national gas regulations shall be observed. Keep ventilation openings clear of obstruction.
- The appliance shall be stored so as to prevent mechanical damage from occurring.
- A warning that the appliance shall be stored in a well-ventilated area where the room size corresponds to the room area as specified for operation.
- Any person who is involved with working on or breaking into a refrigerant circuit should hold a current valid certificate from an industry-accredited assessment authority, which authorises their competence to handle refrigerants safely in accordance with an industry recognised assessment specification.
- Servicing shall only be performed as recommended by the equipment manufacturer. Maintenance and repair requiring the assistance of other skilled personnel shall be carried out under the supervision of the person competent in the use of flammable refrigerants.
- Please follow the instruction carefully to handle, install, clear, service the air conditioner to avoid any damage or hazard. Flammable Refrigerant is used within air conditioner. When maintaining or disposing the air conditioner, the refrigerant (R32 or R290) shall be recovered properly, shall not discharge to air directly.
- No any open fire or device like switch which may generate spark/arcing shall be around air conditioner to avoid causing ignition of the flammable refrigerant used.
- Please follow the instruction carefully to store or maintain the air conditioner to prevent mechanical damage from occurring.
- Flammable refrigerant is used in air conditioner. Please follow the instruction carefully to avoid any hazard. For special information on the type of gas and the amount, please to the relevant label on the unit itself.
- The appliance shall be stored in a room without continuously operating open flames (for example an operating gas appliance) and ignition sources (for example an operating electric heater).



**Caution:
Risk of fire/flammable materials
(Required for R32/R290 units only)**

Explanation of symbols displayed on the unit (For the unit adopts R32/R290 Refrigerant only):

	WARNING	This symbol shows that this appliance used a flammable refrigerant. If the refrigerant is leaked and exposed to an external ignition source, there is a risk of fire.
	CAUTION	This symbol shows that the operation manual should be read carefully.
	CAUTION	This symbol shows that a service personnel should be handling this equipment with reference to the installation manual.
	CAUTION	This symbol shows that information is available such as the operating manual or installation manual.

1. Transport of equipment containing flammable refrigerants See transport regulations
2. Marking of equipment using signs See local regulations.
3. Disposal of equipment using flammable refrigerants See national regulations.
4. Storage of equipment/appliances The storage of equipment should be in accordance with the manufacturer's instructions.
5. Storage of packed (unsold) equipment Storage package protection should be constructed such that mechanical damage to the equipment inside the package will not cause a leak of the refrigerant charge. The maximum number of pieces of equipment permitted to be stored together will be determined by local regulations.

6. Information on servicing

1) Checks to the area

Prior to beginning work on systems containing flammable refrigerants, safety checks are necessary to ensure that the risk of ignition is minimised. For repair to the refrigerating system, the following precautions shall be complied with prior to conducting work on the system.

2) Work procedure

Work shall be undertaken under a controlled procedure so as to minimise the risk of a flammable gas or vapour being present while the work is being performed.

3) General work area

All maintenance staff and others working in the local area shall be instructed on the nature of work being carried out. Work in confined spaces shall be avoided. The area around the workspace shall be sectioned off. Ensure that the conditions within the area have been made safe by control of flammable material.

4) Checking for presence of refrigerant

The area shall be checked with an appropriate refrigerant detector prior to and during work, to ensure the technician is aware of potentially flammable atmospheres. Ensure that the leak detection equipment being used is suitable for use with flammable refrigerants, i.e. non-sparking, adequately sealed or intrinsically safe.

5) Presence of fire extinguisher

If any hot work is to be conducted on the refrigeration equipment or any associated parts, appropriate fire extinguishing equipment shall be available to hand. Have a dry powder or CO₂ fire extinguisher adjacent to the charging area.

6) No ignition sources

No person carrying out work in relation to a refrigeration system which involves exposing any pipe work that contains or has contained flammable refrigerant shall use any sources of ignition in such a manner that it may lead to the risk of fire or explosion. All possible ignition sources, including cigarette smoking, should be kept sufficiently far away from the site of installation, repairing, removing and disposal, during which flammable refrigerant can possibly be released to the surrounding space. Prior to work taking place, the area around the equipment is to be surveyed to make sure that there are no flammable hazards or ignition risks. No Smoking signs shall be displayed.

7) Ventilated area

Ensure that the area is in the open or that it is adequately ventilated before breaking into the system or conducting any hot work. A degree of ventilation shall continue during the period that the work is carried out. The ventilation should safely disperse any released refrigerant and preferably expel it externally into the atmosphere.

8) Checks to the refrigeration equipment

Where electrical components are being changed, they shall be fit for the purpose and to the correct specification. At all times the manufacturer's maintenance and service guidelines shall be followed. If in doubt consult the manufacturer's technical department for assistance. The following checks shall be applied to installations using flammable refrigerants: The charge size is in accordance with the room size within which the refrigerant containing parts are installed; The ventilation machinery and outlets are operating adequately and are not obstructed; If an indirect refrigerating circuit is being used, the secondary circuit shall be checked for the presence of refrigerant; Marking to the equipment continues to be visible and legible. Markings and signs that are illegible shall be corrected; Refrigeration pipe or components are installed in a position where they are unlikely to be exposed to any substance which may corrode refrigerant containing components, unless the components are constructed of materials which are inherently resistant to being corroded or are suitably protected against being so corroded.

9)Checks to electrical devices

Repair and maintenance to electrical components shall include initial safety checks and component inspection procedures. If a fault exists that could compromise safety, then no electrical supply shall be connected to the circuit until it is satisfactorily dealt with. If the fault cannot be corrected immediately but it is necessary to continue operation, an adequate temporary solution shall be used. This shall be reported to the owner of the equipment so all parties are advised.

Initial safety checks shall include:

That capacitors are discharged: this shall be done in a safe manner to avoid possibility of sparking; That there no live electrical components and wiring are exposed while charging, recovering or purging the system; That there is continuity of earth bonding.

7.Repairs to sealed components

1)During repairs to sealed components, all electrical supplies shall be disconnected from the equipment

being worked upon prior to any removal of sealed covers, etc. If it is absolutely necessary to have an electrical supply to equipment during servicing, then a permanently operating form of leak detection shall be located at the most critical point to warn of a potentially hazardous situation.

2)Particular attention shall be paid to the following to ensure that by working on electrical components, the casing is not altered in such a way that the level of protection is affected. This shall include damage to cables, excessive number of connections, terminals not made to original specification, damage to seals, incorrect fitting of glands, etc. Ensure that apparatus is mounted securely. Ensure that seals or sealing materials have not degraded such that they no longer serve the purpose of preventing the ingress of flammable atmospheres. Replacement parts shall be in accordance with the manufacturer's specifications.

NOTE: The use of silicon sealant may inhibit the effectiveness of some types of leak detection equipment. Intrinsically safe components do not have to be isolated prior to working on them.

8.Repair to intrinsically safe components

Do not apply any permanent inductive or capacitance loads to the circuit without ensuring that this will not exceed the permissible voltage and current permitted for the equipment in use. Intrinsically safe components are the only types that can be worked on while live in the presence of a flammable atmosphere. The test apparatus shall be at the correct rating. Replace components only with parts specified by the manufacturer. Other parts may result in the ignition of refrigerant in the atmosphere from a leak.

9.Cabling

Check that cabling will not be subject to wear, corrosion, excessive pressure, vibration, sharp edges or any other adverse environmental effects. The check shall also take into account the effects of aging or continual vibration from sources such as compressors or fans.

10.Detection of flammable refrigerants

Under no circumstances shall potential sources of ignition be used in the searching for or detection of refrigerant leaks. A halide torch (or any other detector using a naked flame) shall not be used.

11.Leak detection methods

The following leak detection methods are deemed acceptable for systems containing flammable refrigerants. Electronic leak detectors shall be used to detect flammable refrigerants, but the sensitivity may not be adequate, or may need re-calibration. (Detection equipment shall be calibrated in a refrigerant-free area.) Ensure that the detector is not a potential source of ignition and is suitable for the refrigerant used. Leak detection equipment shall be set at a percentage of the LFL of the refrigerant and shall be calibrated to the refrigerant employed and the appropriate percentage of gas (25 % maximum) is confirmed.

Leak detection fluids

are suitable for use with most refrigerants but the use of detergents containing chlorine shall be avoided as the chlorine may react with the refrigerant and corrode the copper pipe-work. If a leak is suspected, all naked flames shall be removed/extinguished. If a leakage of refrigerant is found which requires brazing, all of the refrigerant shall be recovered from the system, or isolated (by means of shut off valves) in a part of the system remote from the leak. Oxygen free nitrogen (OFN) shall then be purged through the system both before and during the brazing process.

12. Removal and evacuation

When breaking into the refrigerant circuit to make repairs or for any other purpose conventional procedures shall be used. However, it is important that best practice is followed since flammability is a consideration. The following procedure shall be adhered to: Remove refrigerant; Purge the circuit with inert gas; Evacuate; Purge again with inert gas; Open the circuit by cutting or brazing.

The refrigerant charge shall be recovered into the correct recovery cylinders. The system shall be flushed with OFN to render the unit safe. This process may need to be repeated several times. Compressed air or oxygen shall not be used for this task. Flushing shall be achieved by breaking the vacuum in the system with OFN and continuing to fill until the working pressure is achieved, then venting to atmosphere, and finally pulling down to a vacuum. This process shall be repeated until no refrigerant is within the system. When the final OFN charge is used, the system shall be vented down to atmospheric pressure to enable work to take place. This operation is absolutely vital if brazing operations on the pipe-work are to take place. Ensure that the outlet for the vacuum pump is not close to any ignition sources and there is ventilation available.

13. Charging procedures

In addition to conventional charging procedures, the following requirements shall be followed. Ensure that contamination of different refrigerants does not occur when using charging equipment. Hoses or lines shall be as short as possible to minimise the amount of refrigerant contained in them. Cylinders shall be kept upright.

Ensure that the refrigeration system is earthed prior to charging the system with refrigerant. Label the system when charging is complete (if not already).

Extreme care shall be taken not to overfill the refrigeration system. Prior to recharging the system it shall be pressure tested with OFN. The system shall be leak tested on completion of charging but prior to commissioning. A follow up leak test shall be carried out prior to leaving the site.

14. Decommissioning

Before carrying out this procedure, it is essential that the technician is completely familiar with the equipment and all its detail. It is recommended good practice that all refrigerants are recovered safely. Prior to the task being carried out, an oil and refrigerant sample shall be taken in case analysis is required prior to re-use of reclaimed refrigerant. It is essential that electrical power is available before the task is commenced.

a) Become familiar with the equipment and its operation.

b) Isolate system electrically.

c) Before attempting the procedure ensure that: Mechanical handling equipment is available, if required, for handling refrigerant cylinders; All personal protective equipment is available and being used correctly; The recovery process is supervised at all times by a competent person; Recovery equipment and cylinders conform to the appropriate standards.

d) Pump down refrigerant system, if possible.

e) If a vacuum is not possible, make a manifold so that refrigerant can be removed from various parts of the system.

f) Make sure that cylinder is situated on the scales before recovery takes place.

g) Start the recovery machine and operate in accordance with manufacturer's instructions.

h) Do not overfill cylinders. (No more than 80 % volume liquid charge).

i) Do not exceed the maximum working pressure of the cylinder, even temporarily.

j) When the cylinders have been filled correctly and the process completed, make sure that the cylinders and the equipment are removed from site promptly and all isolation valves on the equipment are closed off.

k) Recovered refrigerant shall not be charged into another refrigeration system unless it has been cleaned and checked. cylinders. (No more than 80 % volume liquid charge).

15. Labelling

Equipment shall be labelled stating that it has been de-commissioned and emptied of refrigerant. The label shall be dated and signed. Ensure that there are labels on the equipment stating the equipment contains flammable refrigerant.

16. Recovery

When removing refrigerant from a system, either for servicing or decommissioning, it is recommended good practice that all refrigerants are removed safely. When transferring refrigerant into cylinders, ensure that only appropriate refrigerant recovery cylinders are employed. Ensure that the correct number of cylinders for holding the total system charge is available. All cylinders to be used are designated for the recovered refrigerant and labelled for that refrigerant (i.e. special cylinders for the recovery of refrigerant). Cylinders shall be complete with pressure relief valve and associated shut-off valves in good working order. Empty recovery cylinders are evacuated and, if possible, cooled before recovery occurs. The recovery equipment shall be in good working order with a set of instructions concerning the equipment that is at hand and shall be suitable for the recovery of flammable refrigerants. In addition, a set of calibrated weighing scales shall be available and in good working order. Hoses shall be complete with leak-free disconnect couplings and in good condition. Before using the recovery machine, check that it is in satisfactory working order, has been properly maintained and that any associated electrical components are sealed to prevent ignition in the event of a refrigerant release.

Consult manufacturer if in doubt. The recovered refrigerant shall be returned to the refrigerant supplier in the correct recovery cylinder, and the relevant Waste Transfer Note arranged. Do not mix refrigerants in recovery units and especially not in cylinders. If compressors or compressor oils are to be removed, ensure that they have been evacuated to an acceptable level to make certain that flammable refrigerant does not remain within the lubricant. The evacuation process shall be carried out prior to returning the compressor to the suppliers. Only electric heating to the compressor body shall be employed to accelerate this process. When oil is drained from a system, it shall be carried out safely.

SPECIFICATIONS

Product Model	MPPD30C	MPPD33H	MPPD40C
Power source	220-240V~ 50Hz, 1Ph		
Cooling capacity	3.00kW	3.38kW	4.0kW
Heating capacity	-----	2.81kW	-----
Rated current	6.0A	8.0A	10.0A
Rated power input	1.15kW	1.45kW	2.0kW
Moisture resistance class	IPX0		

PRODUCT OVERVIEW

NOTE ON ILLUSTRATIONS:

All the illustrations in the manual are for explanation purpose only. Your machine may be slightly different. The actual shape shall prevail. The unit can be controlled by the unit control panel alone or with the remote controller.

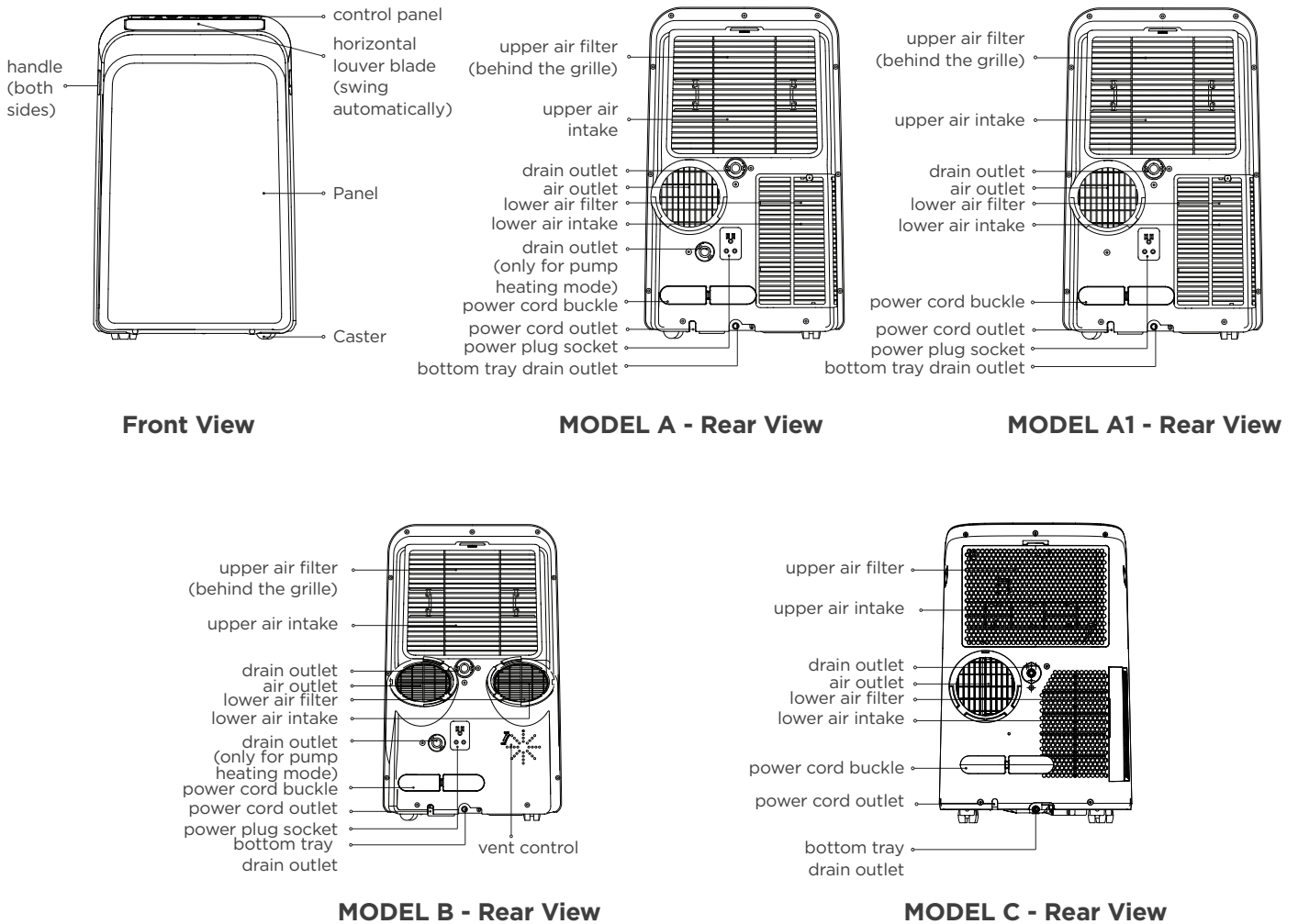

Design Notice

In order to ensure the optimal performance of our products, the design specifications of the unit and remote control are subject to change without prior notice.

CONFIRM IT BEFORE YOU GET START

Ambient Temperature Range For Unit Operating

MODE	Temperature Range	MODE	Temperature Range
Cool	17-35°C (62-95°F)	Heat(pump heat mode)	5-30°C (41-86°F)
Dry	13-35°C (55-95°F)	Heat(electrical heat mode)	≤ 30°C (86°F)

Choose the right position

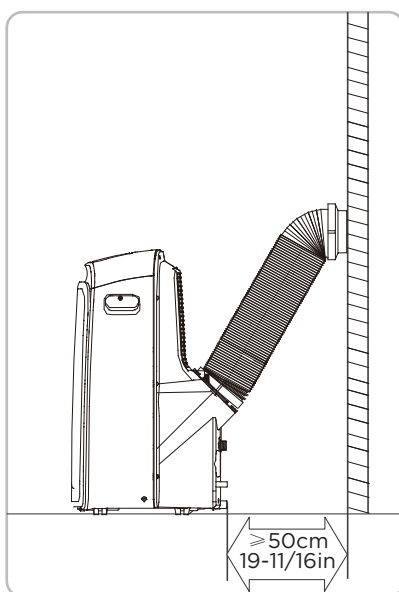
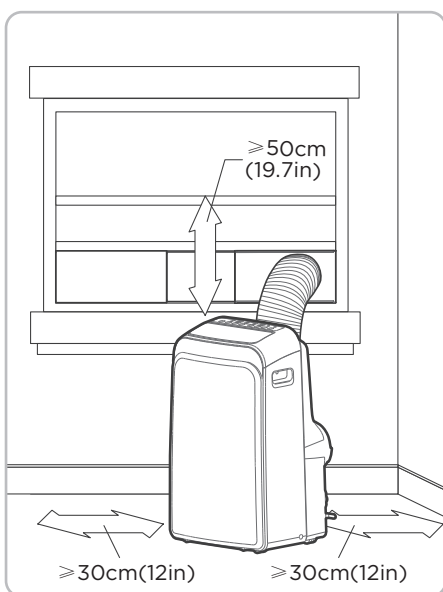

Your installation location should meet the following requirements:

- Make sure that you install your unit on an even surface to minimize noise and vibration.
- The unit must be installed near a grounded plug, and the Collection Tray Drain (found on the back of the unit) must be accessible.
- The unit should be located at least 30cm (12") from the nearest wall to ensure proper air conditioning. The horizontal louver blade should be at least 50cm (19.7") away from obstacles.
- DO NOT cover the Intakes, Outlets or Remote Signal Receptor of the unit, as this could cause damage to the unit.

Energy Rating Information

The energy rating and noise information for this unit is based on the standard installation using an un-extended exhaust duct (Diameter:150mm, Length:1.5m) without window slider adaptor or wall exhaust adaptor A.

The unit with 3 meters extended exhaust duct is running by using 2 exhaust ducts(Diameter:150mm, Length:1.5m + Diameter: 130mm, Length: 1.5m) .The Energy rating and noise information for unit with 3 meters extended exhaust duct is not assessed.(For some models)

NOTE: We recommend that operating the unit at room temperature below 35°C . Since there is a risk that the unit with 3 meters extended exhaust duct would not work at room temperature above 35°C under some extreme conditions, such as the lower air intake be blocked for 50%.

Exhaust Hose Installation

The exhaust hose and adaptor must be installed or removed in accordance with the usage mode. For COOL,HEAT(heat pump type) or AUTO mode must be installed exhaust hose. For FAN, DRY or HEAT (electrical heat type) mode must be removed exhaust hose.

How to Stay Cool with a New Portable Air Conditioner(For the models comply with the requirements of Department Of Energy in US)

Because of a new federal test procedure for Portable Air Conditioners, you may notice that the cooling capacity claims on portable air conditioner packaging are significantly lower than that of models produced prior to 2017. This is due to changes in the test procedure, not to the portable air conditioners themselves.

What should I look for first when purchasing a portable air conditioner?

The right air conditioner helps you cool a room efficiently. An undersized unit won't cool adequately while one that's too large will not remove enough humidity, leaving the air feeling damp. To find the proper air conditioner, determine the square footage of the room you want to cool by multiplying the room length by its width. You also need to know the air conditioner's BTU (British Thermal Unit) rating, which indicates the amount of heat it can remove from a room. A higher number means more cooling power for a larger room. (Be sure you are comparing only newer models to each other- older models may appear to have a higher capacity, but are actually the same). Be sure to "size up" if your portable air conditioner will be placed in a very sunny room, in a kitchen, or in a room with high ceilings. After you've found the right cooling capacity for your room, you can look at other features.

Why is the cooling capacity lower on newer models than on older units?

Federal regulations require manufacturers to calculate cooling capacity based on a specific test procedure, which was changed just this year. Models manufactured before 2017 were tested under a different procedure and cooling capacity is measured differently than in prior years' models. So, while the BTUs may be lower, the actual cooling capacity of the air conditioners has not changed.

What is SACC ?

SACC is the representative value of Seasonally Adjusted Cooling Capacity, in Btu/h, as determined in accordance with the DOE test procedure at title 10 Code of Federal Regulations (CFR) 430, subpart B, appendix CC and applicable sampling plans.

Tools Needed



Medium Philips screwdriver



Pencil



Tape measure or ruler



Scissors or Knife



Saw (On some models, to shorten window adaptor for narrow windows)

Electronic Work

⚠ WARNING:
BEFORE PERFORMING ANY ELECTRICAL OR WIRING WORK, TURN OFF THE MAIN POWER TO THE SYSTEM.

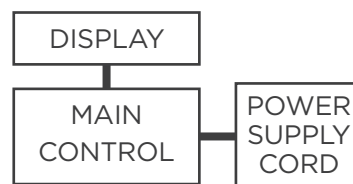

NOTE: The cognographs are for explanation purpose only. Your machine may be slightly different. The actual shape shall prevail.















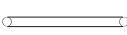
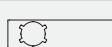

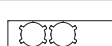

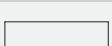
PRODUCTION INSTALLATION

ACCESSORIES













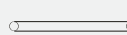







NOTE

Use the accessories packed with the unit to install the machine. The following accessories are for explanatory purposes only. The items are not included with your unit and must be purchased separately.

North America

Shape	Name of Accessories	Qty.		Shape	Name of Accessories	Qty.
		MODEL A	MODEL B			
	Unit Adaptor	1 pc	2 pc		Foam Seal C (Non-adhesive)	1 pc/2 pc(*)
	Exhaust Hose	1 pc	2 pc		Security Bracket and 2 Screws	1 set
	Window Slider Adaptor(*)	1 pc	2 pc		Drain Hose	1 pc
	Window Slider A(*)	1 pc	—		Power Cord Buckle	1 pc
	Window Slider A(*)	—	1 pc		Bolt	1 pc/2 pc/3 pc(*)
	Window Slider B	1 pc(*)			Remote Controller and Battery (only for remote control models)	1 set(*)
	Window Slider C	1 pc(*)			Drain Hose Adaptor (only for heat pump mode)	1 pc(*)
	Foam Seal A (Adhesive)	2 pc/4 pc(*)			Exhaust Hose Adaptor	1 pc(*)
	Foam Seal B (Adhesive)	2 pc			Extended Exhaust Hose	1 pc(*)
	Window Sliders	1 set(*)			Air exhaust passage	1 pc(*)

Other Regions

Shape	Name of Accessories	Qty.	Shape	Name of Accessories	Qty.
	Unit Adaptor	1 pc		Security Bracket and 2 Screws	1 set(*)
	Exhaust Hose	1 pc		Drain Hose	1 pc
	Window Slider Adaptor	1 pc(*)		Power Cord Buckle	1 pc
	Window Slider A	1 pc(*)		Bolt	1 pc(*)
	Window Slider B	1 pc(*)		Remote Controller and Battery (only for remote control models)	1 set(*)
	Foam Seal A (Adhesive)	2 pc(*)		Wall Exhaust Adaptor A (only for wall installation models)	1 pc(*)
	Foam Seal B (Adhesive)	2 pc(*)		Wall Exhaust Adaptor B (with cap) (only for wall installation models)	1 pc(*)
	Foam Seal C (Non-adhesive)	1 pc(*)		Screw and anchor (only for wall installation models)	4 set(*)
	Drain Hose Adaptor (only for heat pump mode)	1 pc(*)		Extended Exhaust Hose	1 pc(*)
	Exhaust Hose Adaptor	1 pc(*)		Air exhaust passage	1 pc(*)
	Window Sliders	1 set(*)			

The accessories with (*) are optional parts.

Step 1: Preparing the Exhaust Hose assembly.

Press the exhaust hose(or extended exhaust hose) into the window slider adaptor(or wall exhaust adaptor) and unit adaptor, clamp automatically by elastic buckles of the adaptors.

Type window installation:

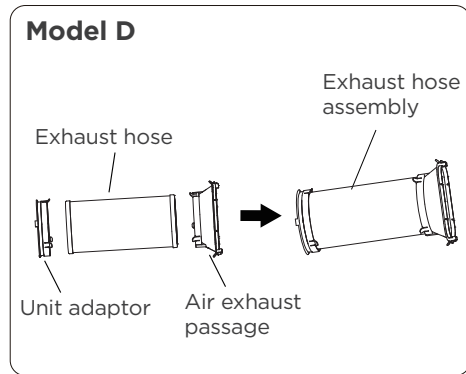
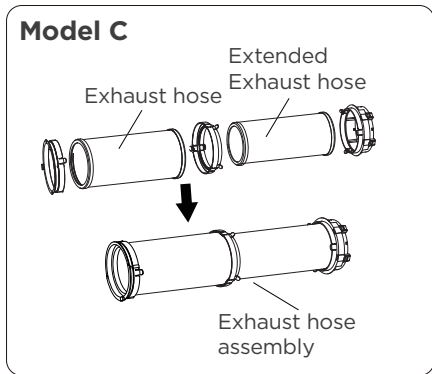
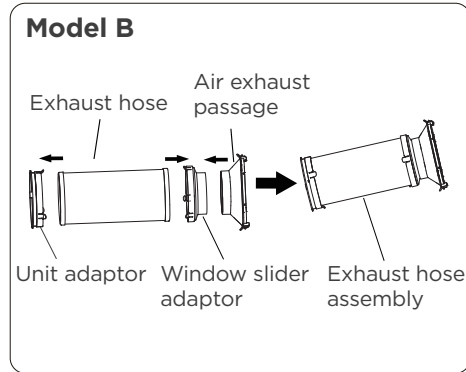
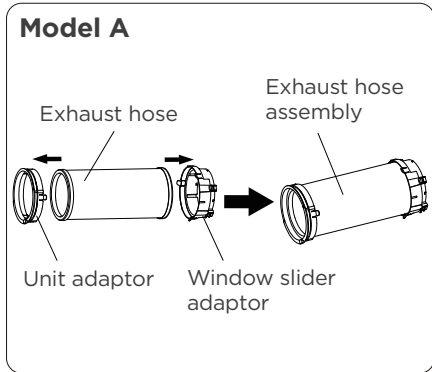

Type wall installation:

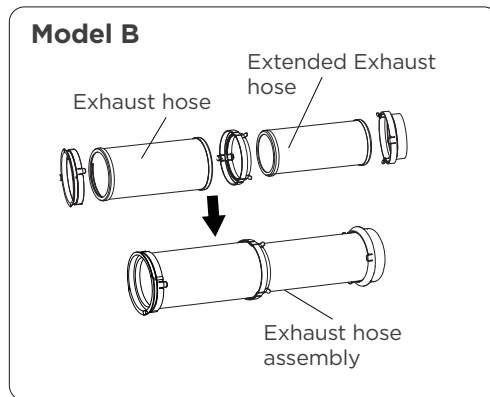
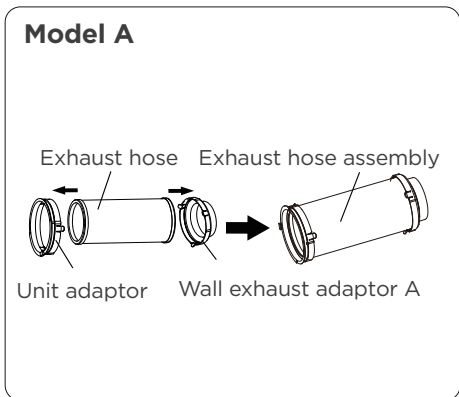

Step 2: Install the Exhaust hose assembly to the unit.

Insert unit adaptor of the Exhaust hose assembly into the lower groove of the air outlet of the unit while the hook of the adaptor is aligned with the hook seat of the air outlet and slide down the Exhaust hose assembly along the arrow direction for installation.

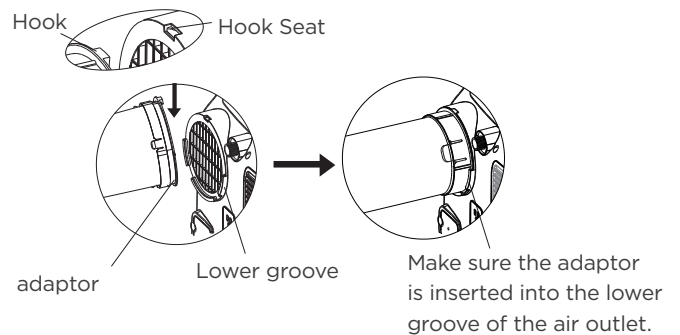

Step 3: Preparing the Adjustable Window Slider.

1. Choose the window sliders according the size of your window. Sometimes, it needs to be cut short to meet the window size, please take extra care to cut it properly.
2. Use bolts to fasten the window sliders once they are adjusted to the Proper length.

Type 1 :

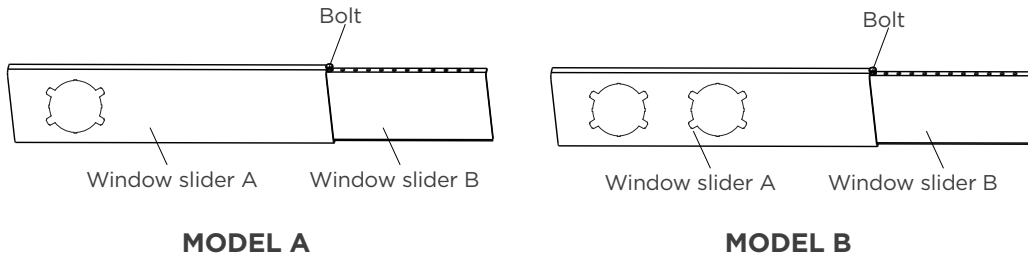

Type 2 :

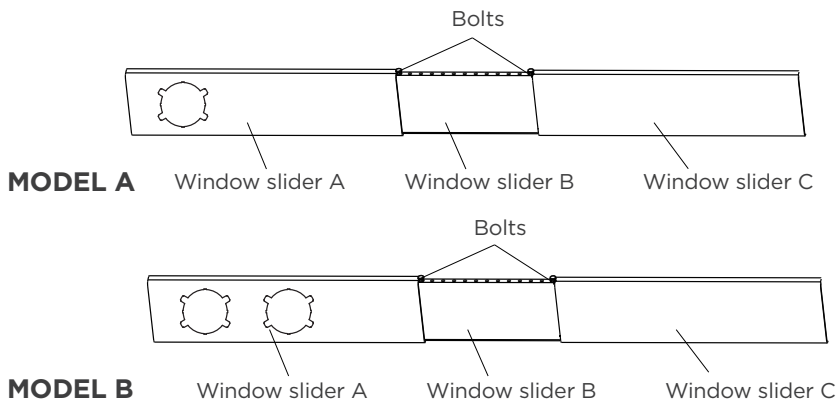

Type 3 :

MODEL C

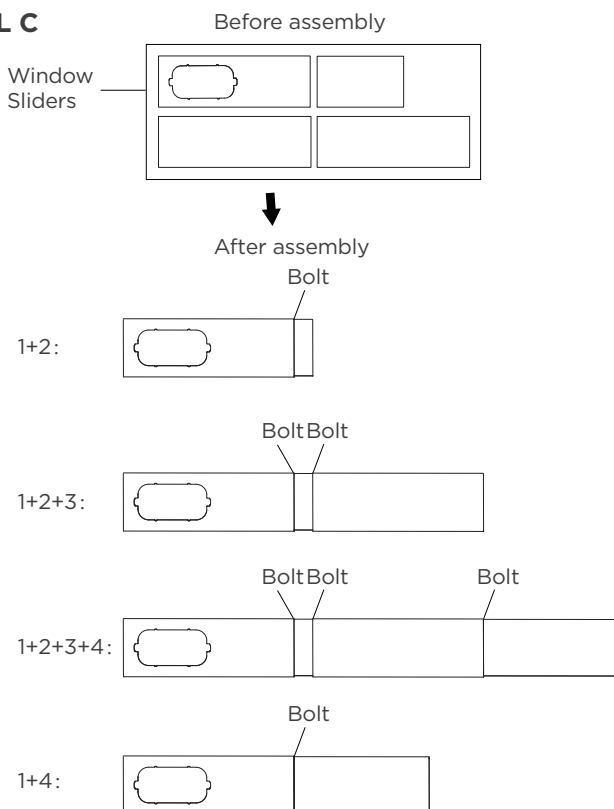

MODEL D

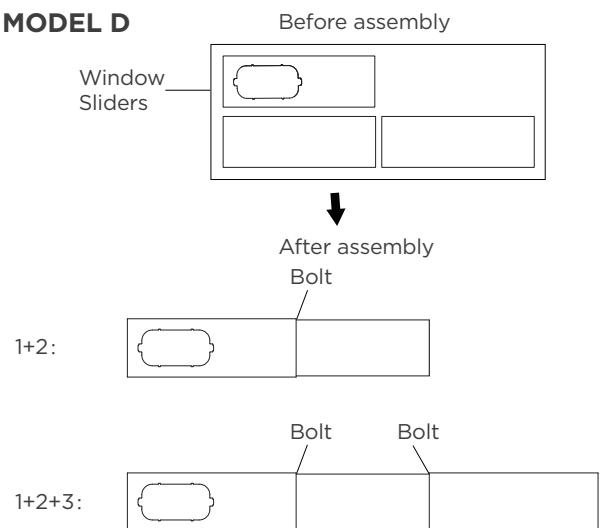

3 Hung window installation or wall installation

NOTE: Once the Exhaust Hose assembly and Adjustable Window Slider are prepared, choose from one of the following two installation methods.

Type 1: Hung Window or Sliding Window Installation(For some models)

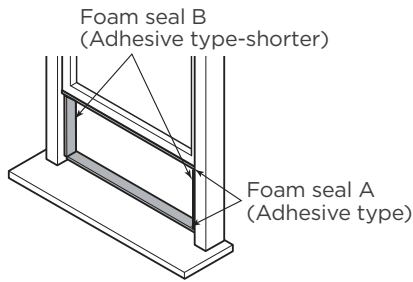

Or

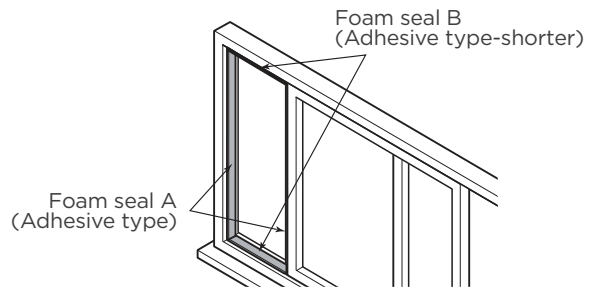

1. Cut the adhesive foam seal A and B strips to the proper lengths, and attach them to the window sash and frame as shown.

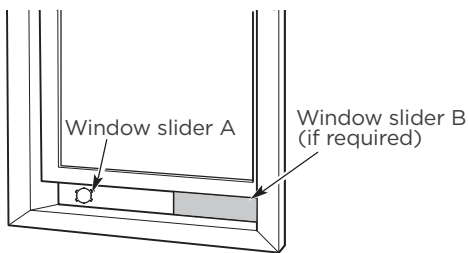

Or

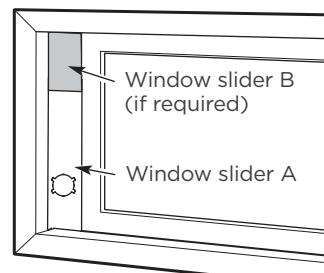

2. Insert the window slider assembly into the window opening.

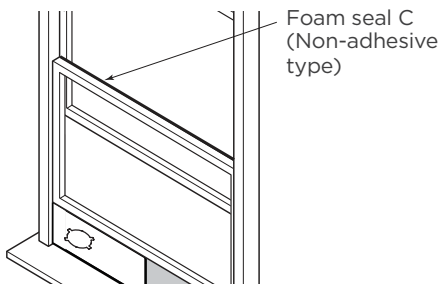

Or

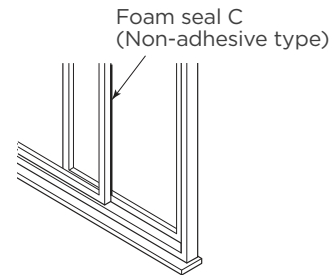

3. Cut the non-adhesive foam seal C strip to match the width(or height) of the window. Insert the seal between the glass and the window frame to prevent air and insects from getting into the room.

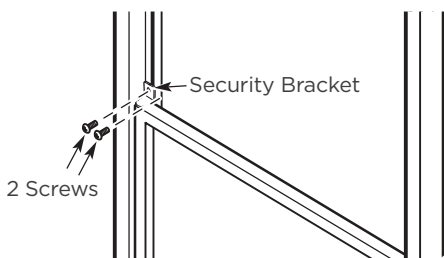

Or

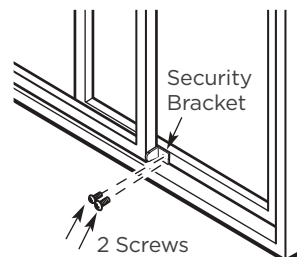

4. If desired, install the security bracket with 2 screws as shown.

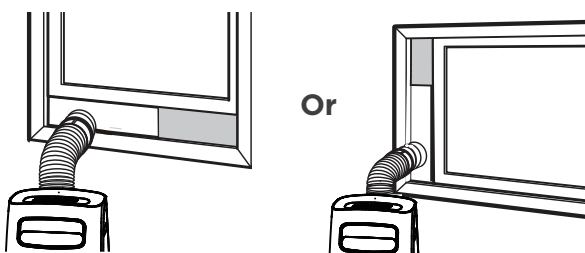

MODEL A

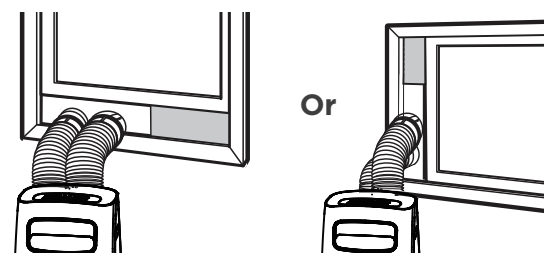

MODEL B

5. Insert the window slider adaptor into the hole of the window slider.

Type 2: Wall Installation(For some models)

NOTE

Cover the hole using the adaptor cap when not in use.

Step 1:

Cut a 125mm (4.9inches) hole into the wall for the Wall Exhaust Adaptor B.

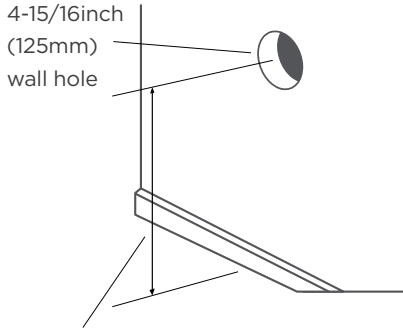

The center of the hole in the wall should be between 80cm(31 inches) and 140cm(55 inches) from the ground.

Step 2:

Secure the Wall Exhaust Adaptor B to the wall using the four Anchors and Screws provided in the kit.

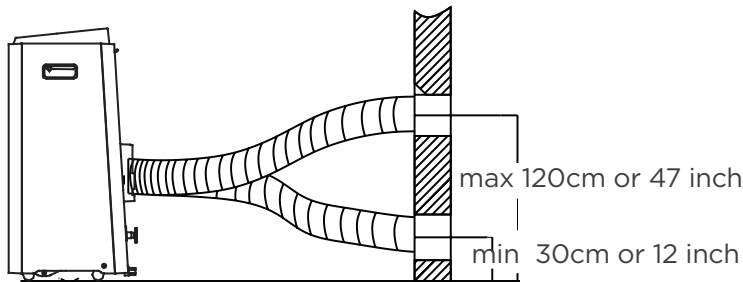
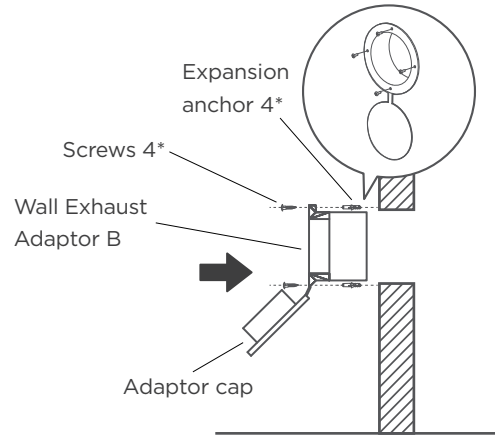

Step 3:

Connect the Exhaust Hose Assembly(with Wall Exhaust Adaptor A) to the Wall Exhaust Adaptor B.

INCORRECT

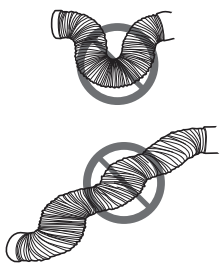

CORRECT

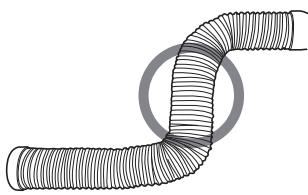

NOTE:

To ensure proper function, DO NOT overextend or bend the hose. Make sure that there is no obstacle around the air outlet of the exhaust hose (in the range of 500mm) in order to the exhaust system works properly. All the illustrations in this manual are for explanation purpose only. Your air conditioner may be slightly different. The actual shape shall prevail.

VENT CONTROL feature(for MODEL B)

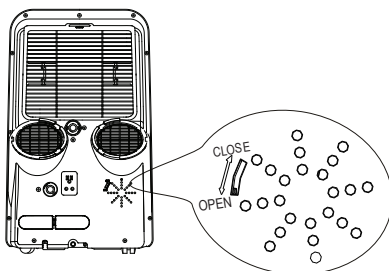

The Vent Control is located at the back of the air conditioner. The OPEN position removes stale air from the room and exhausts it to the outside. Fresh air is drawn in through normal passages in the home. When not need to circulate the room air, set Vent Control to CLOSE position. This function is only applicable for MODEL B.

OPERATION INSTRUCTIONS

Control Panel

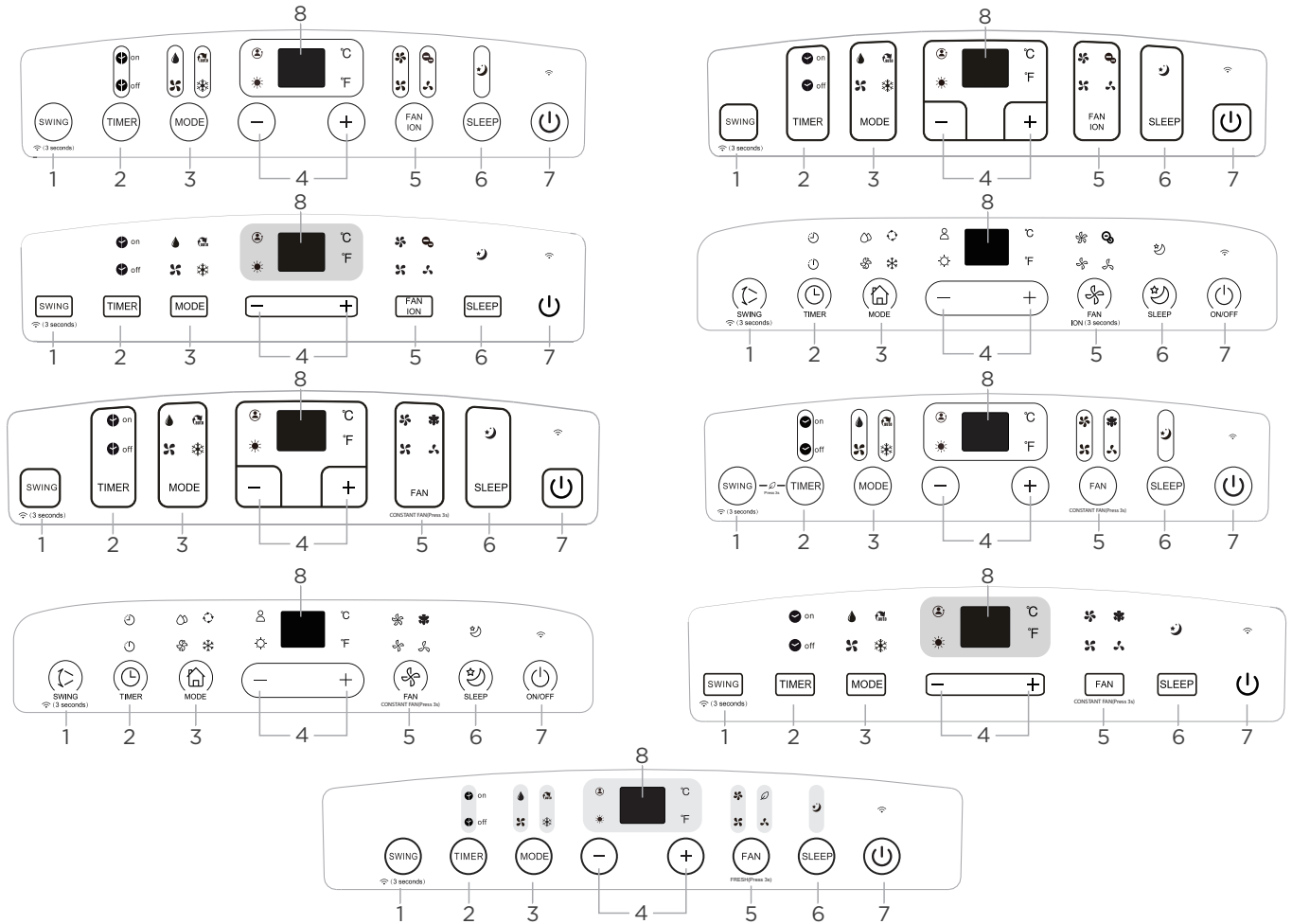

NOTE: On some models is instead of °F. On some models • (power light) is instead of (WIRELESS light).

Indicator	Function	Indicator	Function	Indicator	Function
on /	Timer on light;	/	HIGH fan speed light	/	Heat mode light;
off /	Timer off light;	/	MED fan speed light	°C	Degrees Celsius
	DRY mode light	/	LOW fan speed light	°F	Degrees Fahrenheit
	FAN mode light	/	AUTO fan speed light (all illuminate/all dark)		LED display
	AUTO mode light	/	ION light		Power management light
	COOL mode light	/	SLEEP light	•	Power light
	FOLLOW ME light		Wireless light		Fresh light
	Constant Fan light				

NOTE:

The following control panels are for explanation purpose only. The control panel of the unit you purchased may be slightly different according to the models. Your machine may not contain some indicators or buttons. The actual shape shall prevail.

OPERATION INSTRUCTIONS

		Description
1	Swing - Function Wireless - Function (on some models)	Used to initiate the Auto swing feature. When the operation is ON, press the SWING button can stop the louver at the desired angle. Used to initiate the Wireless function. For the first time to use Wireless function, press and hold the swing button for 3 seconds to initiate the Wireless connection mode. The LED DISPLAY shows 'AP' to indicate you can set Wireless connection. If connection(router) is successful within 8 minutes, the unit will exit Wireless connection mode automatically and the Wireless indicator illuminates. If connection is failure within 8 minutes, the unit exits Wireless connection mode automatically. After Wireless connection is successful, you can press and hold SWING and DOWN (-) buttons at the same time for 3 seconds to turn off Wireless function and the LED DISPLAY shows 'OF' for 3 seconds, press SWING and UP(+) buttons at the same time to turn on Wireless function and the LED DISPLAY shows 'On' for 3 seconds. NOTE: When you restart the Wireless function, it may take a period of time to connect to the network automatically.
2	Timer - Function	Used to initiate the AUTO ON start time and AUTO OFF stop time program, in conjunction with the + & - buttons. The timer on/off indicator light illuminates under the timer on/off settings. <ul style="list-style-type: none"> · When the unit is on, press the Timer button will initiate the Auto-off stop program, the TIMER OFF indicator light illuminates. Press the UP or down button to select the desired time. Press the TIMER button again within 5 seconds, the Auto-on start program is initiated. And the TIMER ON indicator light illuminates. Press the up or down button to select the desired Auto-on start time. · When the unit is off, press the Timer button to initiate the Auto-on start program, press it again within 5 seconds will initiate the Auto-off stop program. · Press or hold the UP or DOWN button to change the Auto time by 0.5 hour increments, up to 10 hours, then at 1 hour increments up to 24 hours. The control will count down the time remaining until start. · The system will automatically revert back to display the previous temperature setting if there is no operation in a 5 seconds period. · Turning the unit ON or OFF at any time or adjusting the timer setting to 0.0 will cancel the Auto Start/Stop timer program.
3	Mode - Function	Selects the appropriate operating mode. Each time you press the button, a mode is selected in a sequence that goes from AUTO), COOL, DRY, FAN and HEAT (cooling only models without). The mode indicator light illuminates under the different mode settings. <p>DRY operation</p> <ul style="list-style-type: none"> · Press the "MODE" button until the "DRY" indicator light comes on. · Under this mode, you cannot select a fan speed or adjust the temperature. The fan motor operates at LOW speed. · Keep windows and doors closed for the best dehumidifying effect. <p>AUTO operation</p> <ul style="list-style-type: none"> · When you set the air conditioner in AUTO mode, it will automatically select cooling, heating(cooling only models without), or fan only operation depending on what temperature you have selected and the room temperature. · The air conditioner will control room temperature automatically round the temperature point set by you. · Under AUTO mode, you can not select the fan speed. <p>NOTE: Under AUTO mode, both the AUTO mode and the actual operation mode indicator lights illuminate for some models.</p> <p>FAN operation</p> <ul style="list-style-type: none"> · Press the "MODE" button until the "FAN " indicator light comes on. · Press the "FAN SPEED" button to choose the fan speed. The temperature can not be adjusted. · Do not put the duct to window.

		Description
4	Up and Down buttons	Used to adjust (increasing/decreasing) temperature settings in 1°C/1°F (or 2 °F) increments in a range of 17°C/62°F to 30°C/86°F (or 88°F) or the TIMER setting in a range of 0-24hrs. NOTE: The control is capable of displaying temperature in degrees Fahrenheit or degrees Celsius. To convert from one to the other, press and hold the Up and Down buttons at the same time for 3 seconds.
5	Fan - Function Constant - Function (on some models) ION/Fresh feature (on some models)	Control the fan speed. Press to select the fan speed in four steps-LOW, MED, HIGH and AUTO. The fan speed indicator light illuminates under different fan settings. When select AUTO fan speed, all the fan indicator lights turn dark. On some models, when select AUTO fan speed, all the fan indicator lights illuminate. Press FAN button for 3 seconds to initiate ION/FRESH feature and the ION/FRESH light illuminates(if applicable), the LED DISPLAY shows 'On' for 3 seconds for some units. The ion generator is energized and will help to purify the air inside. Press it for 3 seconds again to stop the ION/FRESH feature and the ION/FRESH light turn dark(if applicable), the LED DISPLAY shows 'OF' for 3 seconds for some units. Note: For some models, the fan speed can not be adjusted under HEAT mode.
6	Sleep - Function ECO - Function (Optional)	Used to initiate the SLEEP/ECO operation. · Press this button, the selected temperature will increase(cooling) or decrease(heating) by 1°C/2°F(or 1°F) 30 minutes. The temperature will then increase (cooling) or decrease (heating) by another 1°C/2°F(or 1°F) after an additional 30 minutes. This new temperature will be maintained for 7 hours before it returns to the originally selected temperature. This ends the Sleep/Eco mode and the unit will continue to operate as originally programmed. NOTE: This feature is unavailable under FAN or DRY mode.
7	Power ON/OFF	Power switch on/off.
8	LED Display	Shows the set temperature in °C or °F("°F" no display for some models) and the Auto-timer settings. While on DRY and FAN modes, it shows the room temperature. Shows Error codes and protection code: E1-Room temperature sensor error. E2-Evaporator temperature sensor error. E3-Condenser temperature sensor error (On some models). E4-Display panel communication error. EC-Refrigerant leakage detection malfunction (On some models). P1-Bottom tray is full--Connect the drain hose and drain the collected water away.If protection repeats,call for service. Note: When one of the above malfunctions occurs, turn off the unit, and check for any obstructions. Restart the unit, if the malfunction is still present, turn off the unit and unplug the power cord. Contact the manufacturer or its service agents or a similar qualified person for service.

More features

FOLLOW ME/TEMP SENSING feature (On some models)

NOTE: This feature can be activated from the remote control ONLY. The remote control serves as a remote thermostat allowing for the precise temperature control at its location.

To activate the Follow Me/Temp Sensing feature, point the remote control towards the unit and press the Follow Me/Temp Sensing button. The remote control will send this signal to the air conditioner until press the Follow Me/Temp Sensing button again. If the unit does not receive the Follow Me/Temp Sensing signal during any 7 minutes interval, the unit will exit the Follow Me/Temp Sensing mode.

NOTE: This feature is unavailable under FAN or DRY mode.

AUTO-RESTART

If the unit breaks off unexpectedly due to the power cut, it will restart with the previous function setting automatically when the power resumes.

Default Setting

When the air conditioner restarts after a power failure, it will default to the factory settings (AUTO mode, AUTO fan, 24°C (76°F)). This may cause inconsistencies on the remote control and unit panel. Use your remote control to update the status.

Auto-Restart (some models)

In case of power failure, the system will immediately stop. When power returns, the Operation light on the indoor unit will flash. To restart the unit, press the ON/OFF button on the remote control. If the system has an auto restart function, the unit will restart using the same settings.

Three-minute protection feature (some models)

A protection feature prevents the air conditioner from being activated for approximately 3 minutes when it restarts immediately after operation.

AIR FLOW DIRECTION ADJUSTMENT

The louver can be adjusted automatically. Adjust the air flow direction automatically:

- When the Power is ON, the louver opens fully.
- Press the SWING button on the panel or remote controller to initiate the Auto swing feature. The louver will swing up and down automatically.
- Please do not adjust the louver manually.

WAIT 3 MINUTES BEFORE RESUMING OPERATION

After the unit has stopped, it can not be restarted operation in the first 3 minutes. This is to protect the unit. Operation will automatically start after 3 minutes.

NOTE:

Under cooling operation, when the ambient temperature is lower than the setting temperature for a period of time. The compressor and fan motor will stop. When the ambient temperature is higher than the setting temperature, the compressor and (or) fan motor run.

Louver Angle Memory Function (some models)

Some models are designed with a louver angle memory function. When the unit restarts after a power failure, the angle of the horizontal louvers will automatically return to the previous position. The angle of the horizontal louver should not be set too small as condensation may form and drip into the machine. To reset the louver, press the manual button, which will reset the horizontal louver settings.

Refrigerant Leak Detection System (some models)

The indoor unit will automatically display "EC" or "ELOC" or flash LEDS (model dependent) when it detects refrigerant leakage.

Water drainage

- During dehumidifying modes, remove the upper drain plug from the back of the unit, install the drain connector (5/8" universal female mender) with 3/4" hose (locally purchased). For the models without drain connector, just attach the drain hose to the hole. Place the open end of the hose directly over the drain area in your basement floor.

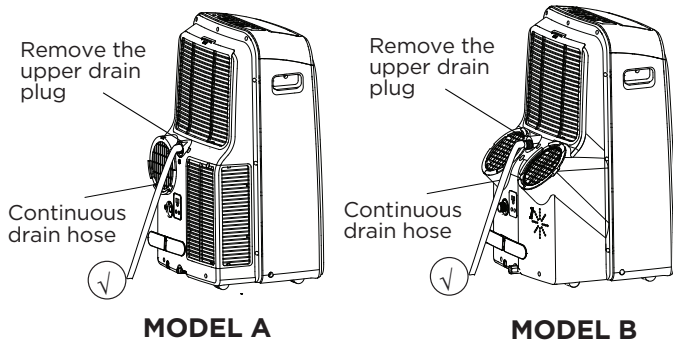

- During heating pump mode, remove the lower drain plug from the back of the unit, install the drain connector (5/8" universal female mender) with 3/4" hose (locally purchased). For the models without drain connector, just attach the drain hose to the hole. Place the open end of the Hose adaptor directly over the drain area in your basement floor.

NOTE: Make sure the hose is secure so there are no leaks. Direct the hose toward the drain, making sure that there are no kinks that will stop the water flowing. Place the end of the hose into the drain and make sure the end of the hose is down to let the water flow smoothly. (See Figs with ✓). Do not let it up. (See Figs with ✗). When the continuous drain hose is not used, ensure that the corresponding drain plug and knob are installed firmly to prevent leakage.

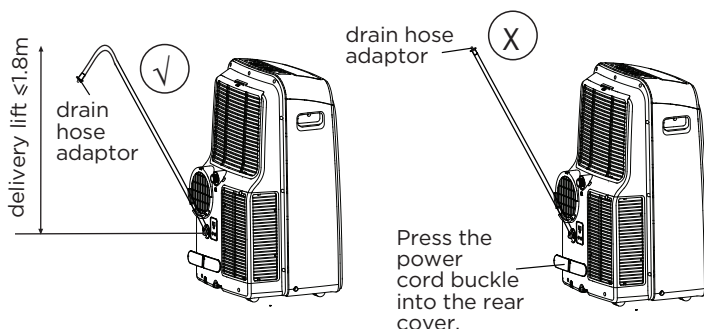
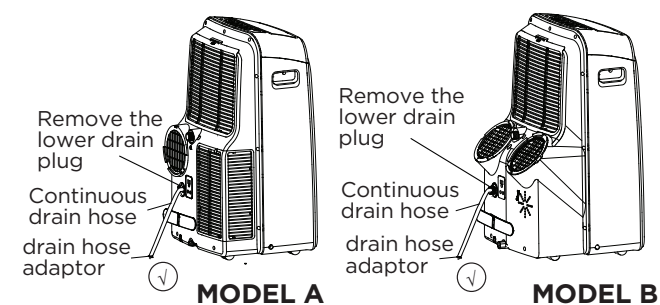

- (For model A1) During heating pump mode, remove the lower drain plug from the back of the unit, install the drain connector (5/8" universal female mender) with 3/4" hose (locally purchased). Carefully move the unit to a drain location, and let the water drain away.

Note: Make sure the drain hose is lower than the bottom tray drain outlet.

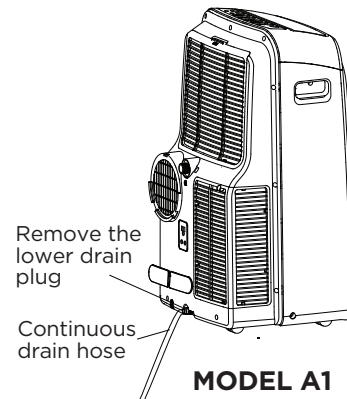

- When the water level of the bottom tray reaches a predetermined level, the unit beeps 8 times, the digital display area shows "P1". At this time the air conditioning/dehumidification process will immediately stop. However, the fan motor will continue to operate (this is normal). Carefully move the unit to a drain location, remove the bottom drain plug and let the water drain away. Reinstall the bottom drain plug and restart the machine until the "P1" symbol disappears. If the error repeats, call for service.

NOTE: Be sure to reinstall the bottom drain plug firmly to prevent leakage before using the unit.

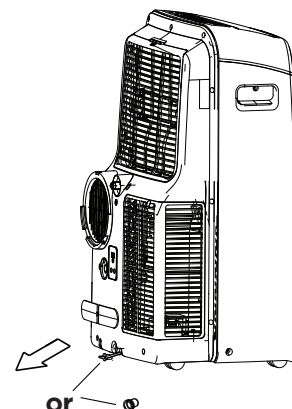

Remote Controller Specifications

Model	RG10F(B)/BGEF、RG10F1(B)/BGEF、RG10F2(B1)/BGEFU1、RG10F3(B1)/BGEFU1
Rated Voltage	3.0V(Dry batteries R03/LR03×2)
Signal Receiving Range	8m
Environment	-5°C-60°C(23°F-140°F)

Quick Start Guide

1 FIT BATTERIES

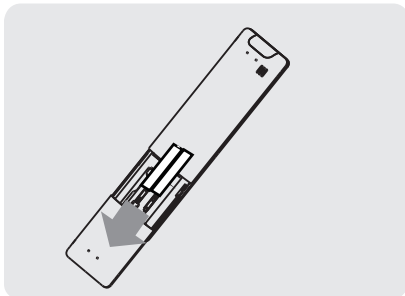

2 SELECT MODE

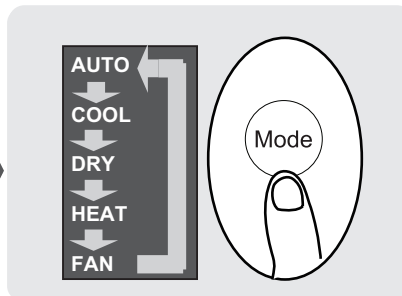

3 SELECT TEMPERATURE

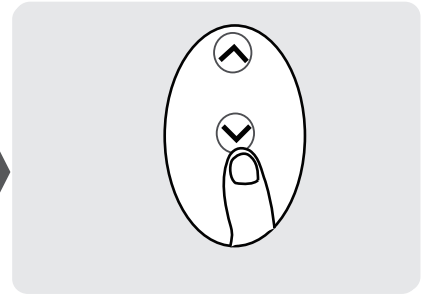

4 SELECT FAN SPEED

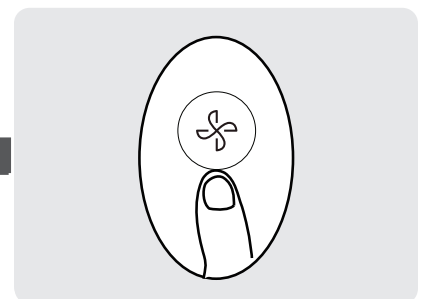

5 POINT REMOTE TOWARD UNIT



6 PRESS POWER BUTTON

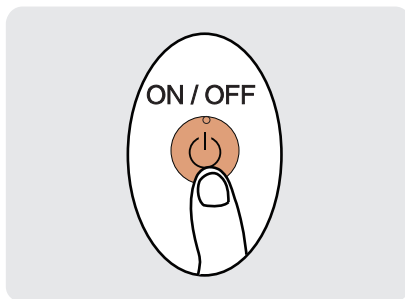

NOT SURE WHAT A FUNCTION DOES?

Refer to the How to Use Basic Functions and **How to Use Advanced Functions** sections of this manual for a detailed description of how to use your air conditioner.

SPECIAL NOTE

- Button designs on your unit may differ slightly from the example shown.
- If the indoor unit does not have a particular function, pressing that function's button on the remote control will have no effect.
- When there are wide differences between "Remote controller Manual" and "USER'S MANUAL" on function description, the description of "USER'S MANUAL" shall prevail.

Handling the Remote Controller

Inserting and Replacing Batteries

Your air conditioning unit may come with two batteries(not all units). Put the batteries in the remote control before use.

1. Slide the back cover from the remote control downward, exposing the battery compartment.
2. Insert the batteries, paying attention to match up the (+) and (-) ends of the batteries with the symbols inside the battery compartment.
3. Slide the battery cover back into place.

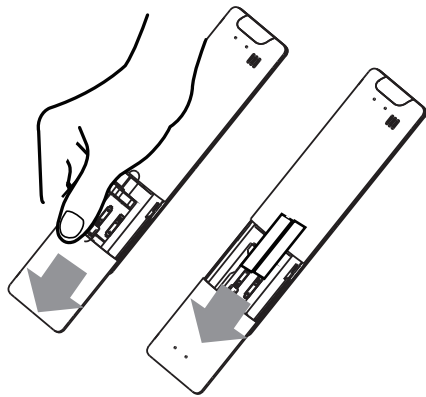

Remote Control

- Direct sunlight can interfere with the infrared signal receiver.
- There must be a clear line of sight between the remote and the device.
- If the signals from the remote control happen to control another appliance, move the appliance to another location or contact customer service.

! Battery Disposal

- Do not dispose of batteries as unsorted municipal waste. Refer to local laws for proper disposal of batteries.
- Batteries may have a chemical symbol at the bottom of the disposal icon. This chemical symbol means that the battery contains a heavy metal that exceeds a certain concentration. An example is Pb: Lead (>0.004%).
- Appliances and used batteries must be treated in a specialized facility for reuse, recycling and recovery. By ensuring correct disposal, you will help avoid possible negative consequences for the environment and human health.



Battery Performance

For optimal product performance:

- Do not mix old and new batteries, or batteries of different brands.
- Do not leave batteries in the remote control if you don't plan on using the device for more than 2 months.

NOTES FOR USING REMOTE CONTROL

The device could comply with the local national regulations.

- In Canada, it should comply with CAN ICES-3(B)/NMB-3(B).
- In USA, this device complies with part 15 of the FCC Rules. Operation is subject to the following two conditions:
 - (1) This device may not cause harmful interference, and
 - (2) this device must accept any interference received, including interference that may cause undesired operation.

This equipment has been tested and found to comply with the limits for a Class B digital device, pursuant to part 15 of the FCC Rules. These limits are designed to provide reasonable protection against harmful interference in a residential installation. This equipment generates, uses and can radiate radio frequency energy and, if not installed and used in accordance with the instructions, may cause harmful interference to radio communications. However, there is no guarantee that interference will not occur in a particular installation. If this equipment does cause harmful interference to radio or television reception, which can be determined by turning the equipment off and on, the user is encouraged to try to correct the interference by one or more of the following measures:







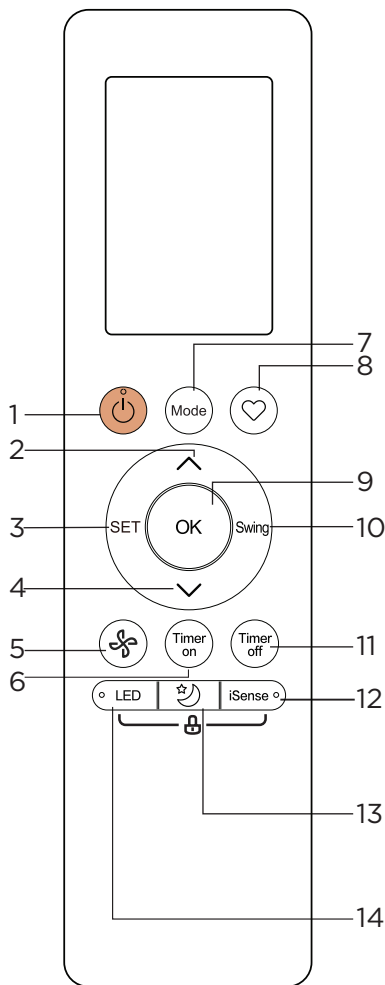



- Reorient or relocate the receiving antenna.
- Increase the separation between the equipment and receiver.
- Connect the equipment into an outlet on a circuit different from that to which the receiver is connected.
- Consult the dealer or an experienced radio/TV technician for help.
- Changes or modifications not approved by the party responsible for compliance could void user's authority to operate the equipment.

Buttons and Functions

Before you begin using your new air conditioner, make sure to familiarize yourself with its remote control. The following is a brief introduction to the remote control itself. For instructions on how to operate your air conditioner, refer to the **How to Use Basic Functions** section of this manual.



Model:
RG10F(B)/BGEF
(Fresh feature is not available)
RG10F1(B)/BGEF

Description	
No.1	 ON/OFF Turns the unit on or off.
No.2	 TEMP Increases temperature in 1°C increments. Max. temperature is 30°C.
No.3	SET SET Scrolls through operation functions as follows: Fresh() → AP mode() → Fresh... The selected symbol will flash on the display area, press the OK button to confirm.
No.4	 TEMP Decreases temperature in 1°C increments. Min. temperature is 17°C.
No.5	 FAN SPEED Selects fan speeds in the following order: AUTO → LOW → MED → HIGH
No.6	 TIMER ON Sets timer to turn unit on (see How to Use Basic Functions for instructions).
No.7	 MODE Scrolls through operation modes as follows: AUTO → COOL → DRY → HEAT → FAN NOTE: Please do not select HEAT mode if the machine you purchased is cooling only type. Heat mode is not supported by the cooling only appliance.
No.8	 SHORTCUT Used to restore the current settings or resume previous settings.
No.9	OK OK Used to confirm the selected functions.
No.10	Swing SWING Starts and stops the horizontal louver movement. Hold down for 2 seconds to initiate vertical louver auto swing feature.
No.11	 TIMER OFF Sets timer to turn unit off (see How to Use Basic Functions for instructions).
No.12	iSense I SENSE Press this button to activate the I SENSE mode.
No.13	 SLEEP Saves energy during sleeping hours.
No.14	LED LED Turns indoor unit's LED display and air conditioner buzzer on and off (model dependent), which create a comfortable and quiet environment.

Buttons and Functions

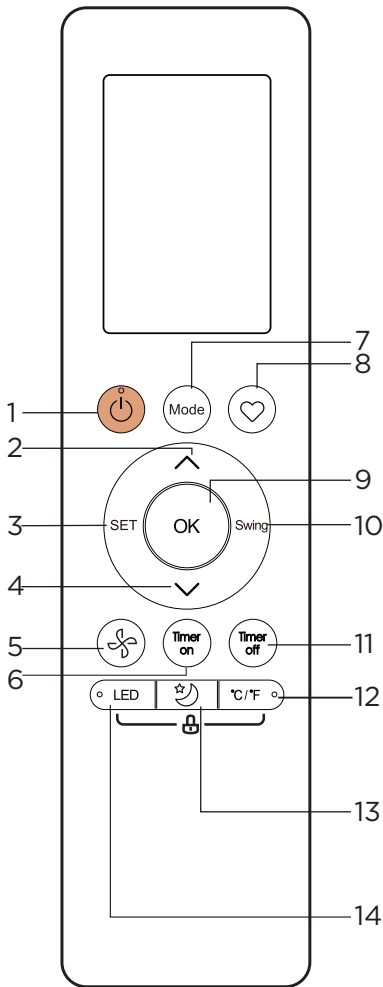

Model:
 RG10F2(B1)/BGEFU1
 (Fresh feature is not available)
 RG10F3(B1)/BGEFU1

Description	
No.1	ON/OFF Turns the unit on or off.
No.2	TEMP Increases temperature in 1°C (1°F) increments. Max. temperature is 30°C (86°F).
No.3	SET SET Scrolls through operation functions as follows: Fresh(∅) → I Sense(☁) → AP mode(⋈) → Fresh... The selected symbol will flash on the display area, press the OK button to confirm.
No.4	TEMP Decreases temperature in 1°C(1°F) increments. Min. temperature is 17°C(62°F).
No.5	FAN SPEED Selects fan speeds in the following order: AUTO → LOW → MED → HIGH
No.6	TIMER ON Sets timer to turn unit on (see How to Use Basic Functions for instructions).
No.7	MODE Scrolls through operation modes as follows: AUTO → COOL → DRY → HEAT → FAN NOTE: Please do not select HEAT mode if the machine you purchased is cooling only type. Heat mode is not supported by the cooling only appliance.
No.8	SHORTCUT Used to restore the current settings or resume previous settings.
No.9	OK OK Used to confirm the selected functions.
No.10	Swing SWING Starts and stops the horizontal louver movement. Hold down for 2 seconds to initiate vertical louver auto swing feature.
No.11	TIMER OFF Sets timer to turn unit off (see How to Use Basic Functions for instructions).
No.12	°C/°F I SENSE The temperature display between the °C & °F.
No.13	SLEEP Saves energy during sleeping hours.
No.14	LED LED Turns indoor unit's LED display and air conditioner buzzer on and off (model dependent), which create a comfortable and quiet environment.

Remote Screen Indicators

Information are displayed when the remote controller is power up.

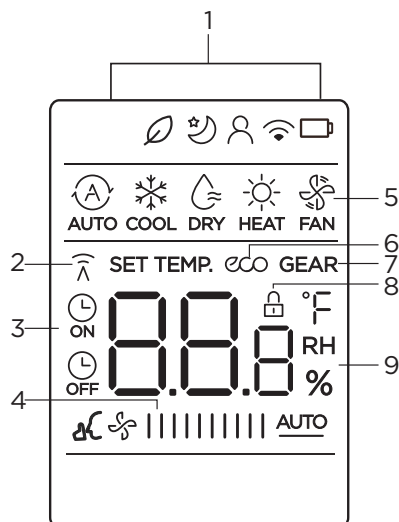

No.1	<ul style="list-style-type: none"> Fresh feature display(some units) (No displays when Fresh feature is activated) Sleep mode display Follow me feature display Wireless control feature display Low battery detection display(If flashes)
No.2	<p>Transmission Indicator Lights up when remote sends signal to indoor unit</p>
No.3	<p> TIMER ON display TIMER OFF display Silence feature display</p>
No.4	<p>FAN SPEED display Displays selected fan speed:</p> <p>LOW </p> <p>MED </p> <p>HIGH </p> <p>AUTO AUTO</p> <p>This fan speed can not be adjusted in AUTO or DRY mode.</p>
No.6	<p>MODE display Displays the current mode, including:</p> <p> AUTO COOL DRY HEAT FAN</p>
No.7	<p>ECO display Not available for this unit</p>
No.8	<p>GEAR display Not available for this unit</p>
No.9	<p>LOCK display Displays when LOCK feature is activated.</p>
No.10	<p>Temperature/Timer/Fan speed display Displays the set temperature by default, or fan speed or timer setting when usingTIMER ON/OFF functions.</p> <ul style="list-style-type: none"> • Temperature range: 17°C-30°C(62 °F-86 °F) • Timer setting range: 0-24 hours <p>This display is blank when operating in FAN mode.</p>

NOTE:

All indicators shown in the figure are for the purpose of clear presentation. But during the actual operation, only the relative function signs are shown on the display window.

How to Use Basic Functions

Basic operation

ATTENTION! Before operation, please ensure the unit is plugged in and power is available.

SETTING TEMPERATURE

The operating temperature range for units is 17°C-30°C (62°F-86°F).

You can increase or decrease the set temperature in 1°C (1°F) increments.

AUTO Mode

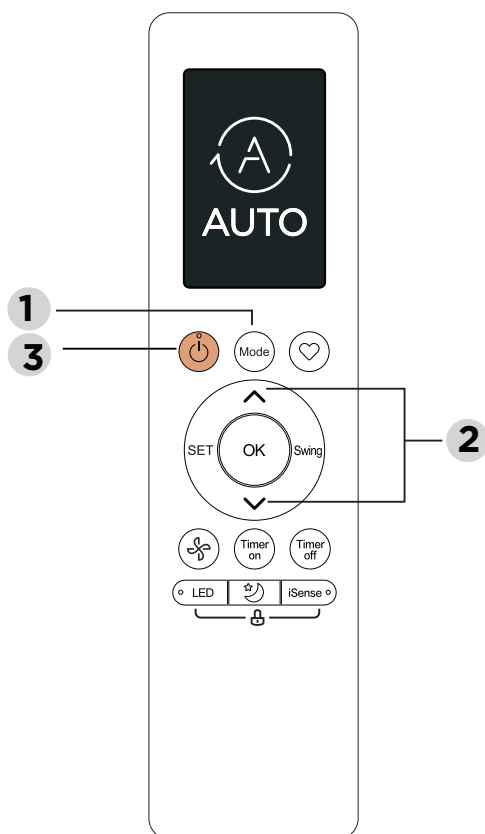

In **AUTO** mode, the unit will automatically select the COOL, FAN, or HEAT function based on the set temperature.

1. Press the **MODE** button to select **AUTO**.
2. Set your desired temperature using the **TEMP ^** or **TEMP v** button.
3. Press the **ON/OFF** button to start the unit.

NOTE: FAN SPEED can't be set in **AUTO** mode.

COOL Mode

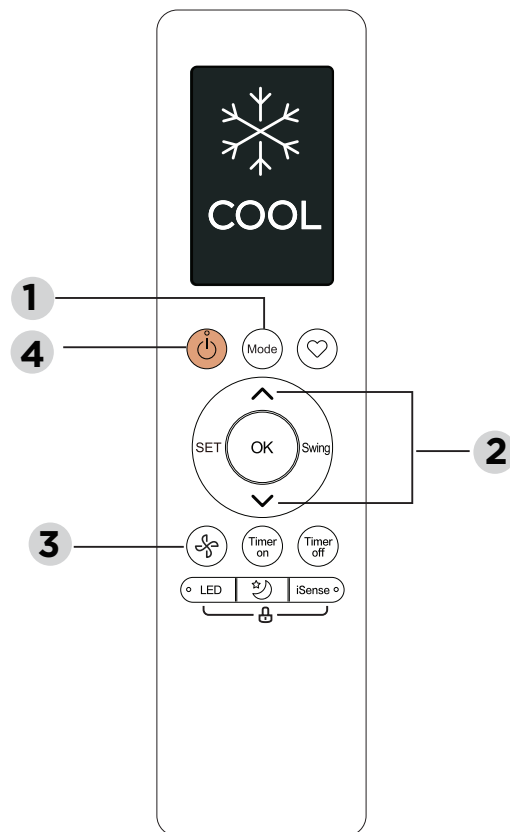

1. Press the **MODE** button to select **COOL** mode.
2. Set your desired temperature using the **TEMP ^** or **TEMP v** button.
3. Press **FAN** button to select the fan speed: AUTO, LOW, MED or HIGH.
4. Press the **ON/OFF** button to start the unit.

How to Use Basic Functions

DRY Mode (dehumidifying)

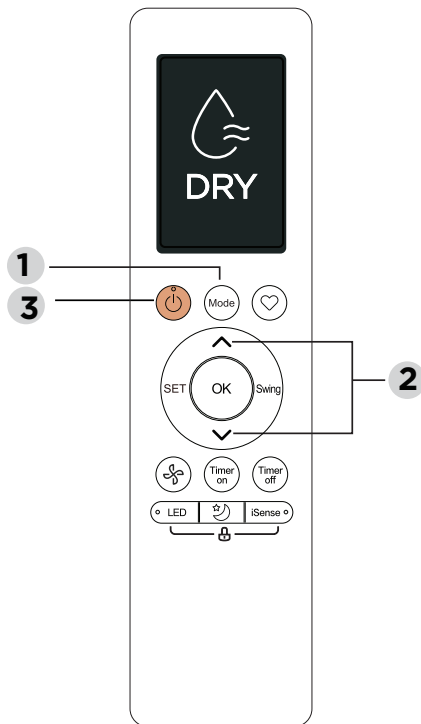

1. Press the **MODE** button to select **DRY**..
2. Set your desired temperature using the **TEMP** \wedge or **TEMP** \vee button.
3. Press the **ON/OFF** button to start the unit.

NOTE: **FAN SPEED** cannot be changed in **DRY** mode.

FAN Mode

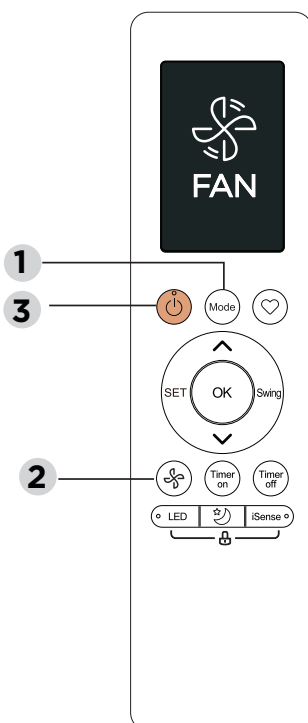

1. Press the **MODE** button to select **FAN** mode.
2. Press FAN button to select the fan speed: AUTO, LOW, MED or HIGH.
3. Press the **ON/OFF** button to start the unit.

NOTE: You can't set temperature in **FAN** mode. As a result, your remote control's **LCD** screen will not display temperature.

HEAT Mode

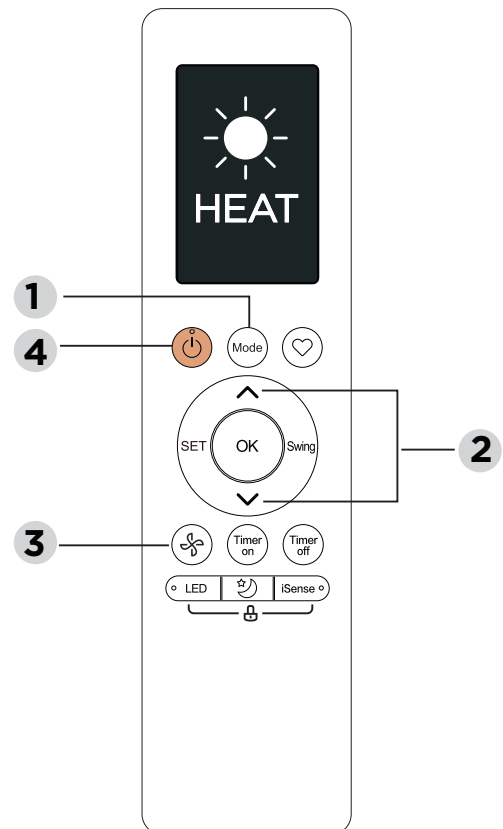

1. Press the **MODE** button to select **HEAT** mode.
2. Set your desired temperature using the **TEMP** \wedge or **TEMP** \vee button.
3. Press FAN button to select the fan speed: AUTO, LOW, MED or HIGH..
4. Press the **ON/OFF** button to start the unit.

NOTE: As outdoor temperature drops, the performance of your unit's **HEAT** function may be affected. In such instances, we recommend using this air conditioner in conjunction with other heating appliances.

How to Use Basic Functions

Setting the TIMER

TIMER ON/OFF - Set the amount of time after which the unit will automatically turn on/off.

TIMER ON setting

Press TIMER ON button to initiate the ON time sequence.



Press up or down button for multiple times to set the desired time to turn on the unit.



Point remote to unit and wait 1sec, the TIMER ON will be activated.



TIMER OFF setting

Press TIMER OFF button to initiate the OFF time sequence.

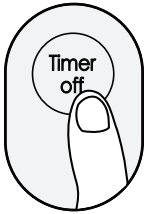

Press Temp. up or down button for multiple times to set the desired time to turn off the unit.



Point remote to unit and wait 1sec, the TIMER OFF will be activated.



NOTE:

- When setting the TIMER ON or TIMER OFF, the time will increase by 30 minutes increments with each press, up to 10 hours. After 10 hours and up to 24, it will increase in 1 hour increments. (For example, press 5 times to get 2.5h, and press 10 times to get 5h,) The timer will revert to 0.0 after 24.
- Cancel either function by setting its timer to 0.0h.

TIMER ON & OFF setting(example)

Keep in mind that the time periods you set for both functions refer to hours after the current time.

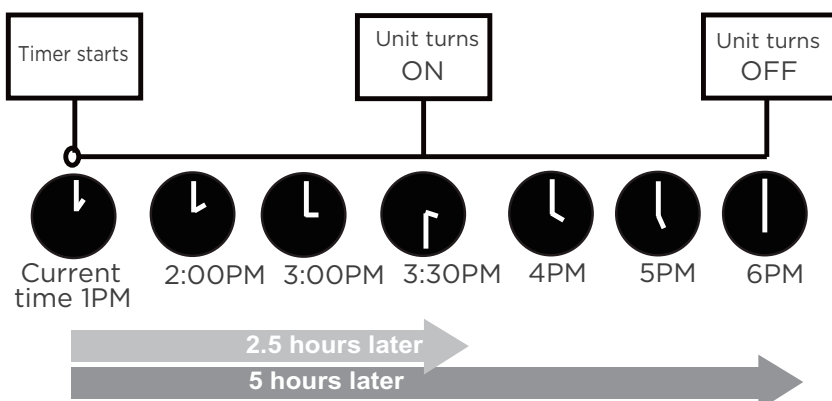
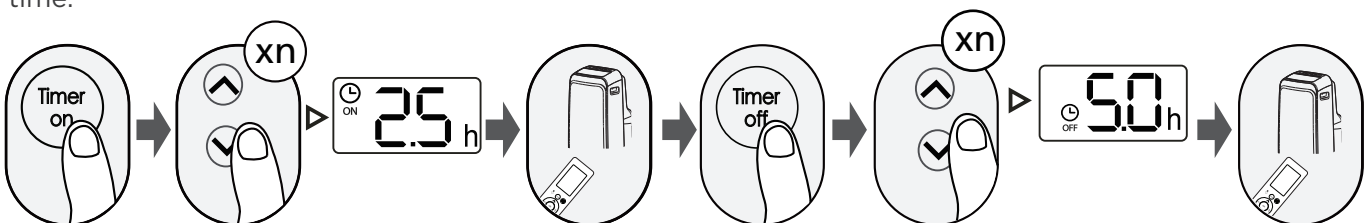

Example: If current timer is 1:00PM, to set the timer as above steps, the unit will turn on 2.5h later (3:30PM) and turn off at 6:00PM.

How to Use Advanced Functions

SHORTCUT function

Press SHORTCUT button

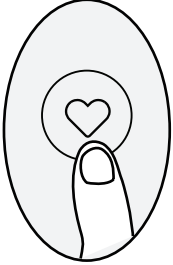

Push this button when remote controller is on, the system will automatically revert back to the previous settings including operating mode, setting temperature, fan speed level and sleep feature (if activated).

If pushing more than 2 seconds, the system will automatically restore the current operation settings including operating mode, setting temperature, fan speed level and sleep feature (if activated).

°C/°F (some models)

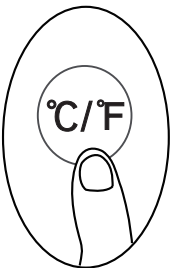

Press this button will alternate the temperature display between the °C & °F.

Swing function

Press Swing button

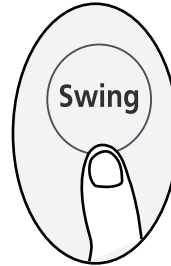

The horizontal louver will swing up and down automatically when pressing Swing button. Press again to make it stop.

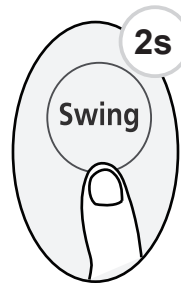

Keep pressing this button more than 2 seconds, the vertical louver swing function is activated. (Model dependent)

LED DISPLAY

Press LED button

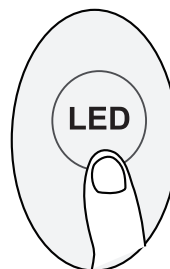

Press this button to turn on and turn off the display on the indoor unit.

How to Use Advanced Functions

SLEEP Function

Press SLEEP button



The SLEEP function is used to decrease energy while you sleep (and don't need the same temperature settings to stay comfortable). This function can only be activated via remote control.

For the details, please see "sleep operation" in "USER'S MANUAL".

NOTE: The SLEEP function is not available in FAN or DRY mode.

I SENSE (some models)

Press I SENSE button

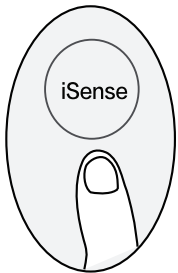

When the I SENSE function is activated, the remote display is actual temperature at its location. The remote control will send this signal to the air conditioner every 3 minutes interval until press the I SENSE button again.

LOCK function

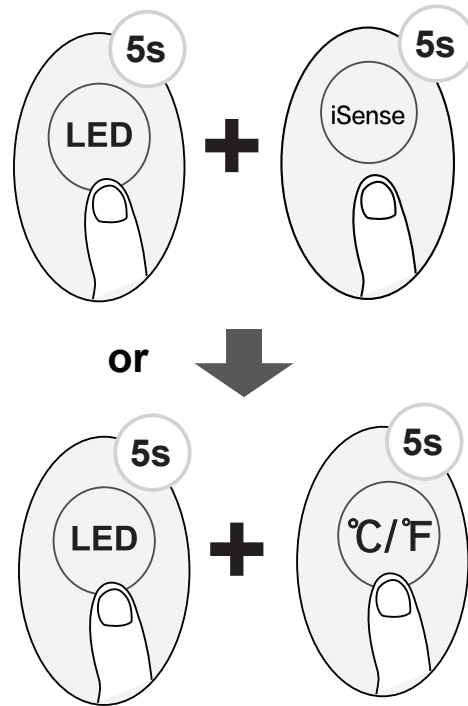

Press together **LED** button and **I SENSE** or **LED** and **°C/°F** button at the same time more than 5 seconds to activate Lock function. All buttons will not response except pressing these two buttons for two seconds again to disable locking.

How to Use Advanced Functions

SET function

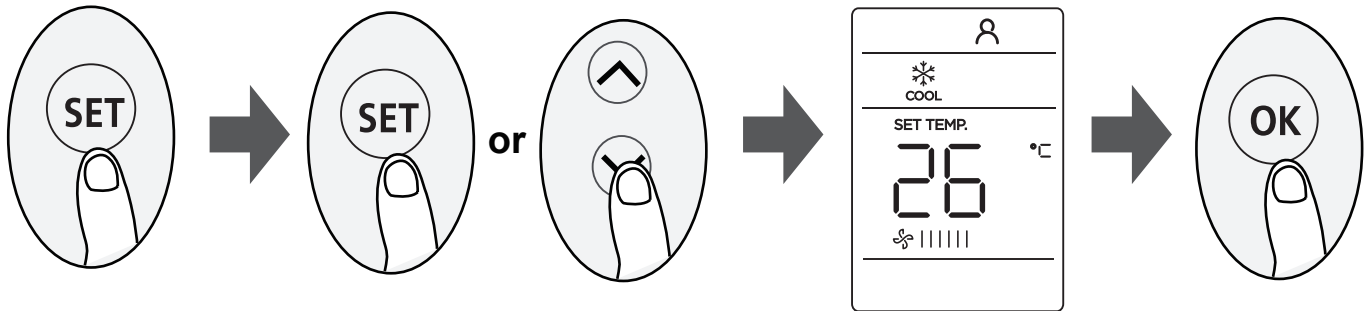

- Press the SET button to enter the function setting, then press SET button or TEMP \downarrow or TEMP \uparrow button to select the desired function. The selected symbol will flash on the display area, press the OK button to confirm.
- To cancel the selected function, just perform the same procedures as above.
- Press the SET button to scroll through operation functions as follows:
Fresh (\varnothing) \rightarrow I Sense* (R) \rightarrow AP mode (W)
[*]: If your remote controller has I Sense button, you can not use the SET button to select the I sense feature.

FRESH function (\varnothing) (some units) :

When the FRESH function is initiated, the Ionizer/Plasma Dust Collector (depending on models) is energized and will help to remove pollen and impurities from the air.

AP function (W) (some units) :

Choose AP mode to do wireless network configuration. For some units, it doesn't work by pressing the SET button. To enter the AP mode, continuously press the LED button seven times in 10 seconds.

CLEANING AND MAINTENANCE

⚠ CAUTION

- Always unplug the unit before cleaning or servicing.
- DO NOT use flammable liquids or chemicals to clean the unit.
- DO NOT wash the unit under running water. Doing so causes electrical danger.
- DO NOT operate the machine if the power supply was damaged during cleaning. A damaged power cord must be replaced with a new cord from the manufacturer.

Air Filter Cleaning

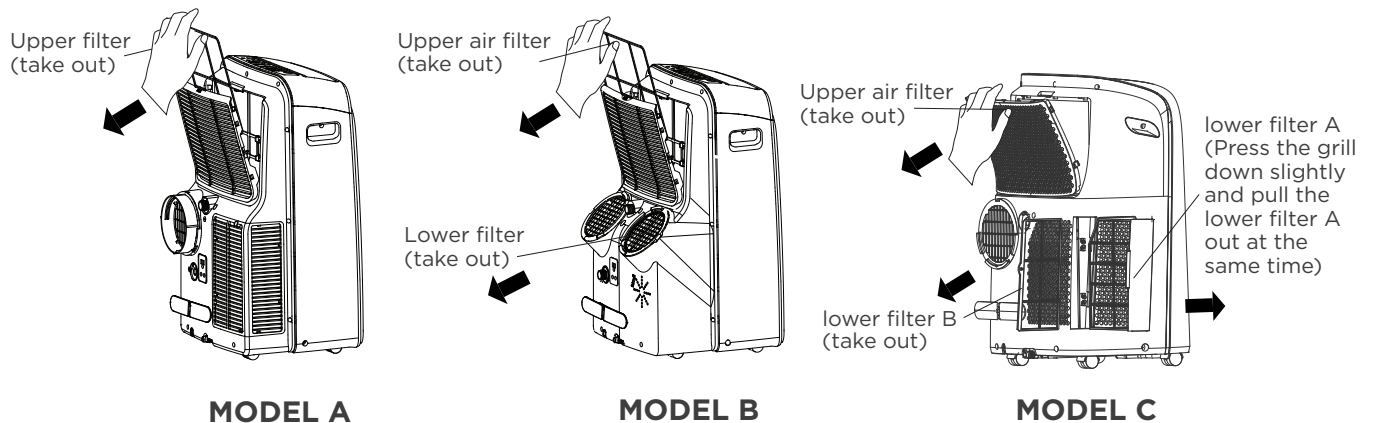

Removal

- Take the filter out along the arrow direction.

Cleaning

- Wash the air filter by immersing it gently in warm water(about 40°C/104°F) with a neutral detergent. Rinse the filter and dry it in a shady place.

Mounting

- Install the air filter after cleaning .

🔧 Maintenance Tips

- Be sure to clean the air filter every 2 weeks for optimal performance.
- The water collection tray should be drained immediately after P1 error occurs, and before storage to prevent mold.
- In households with animals, you will have to periodically wipe down the grill to prevent blocked airflow due to animal hair.

⚠ CAUTION

DO NOT operate the unit without filter because dirt and lint will clog it and reduce performance.

Unit Cleaning

Clean the unit using a damp, lint-free cloth and mild detergent. Dry the unit with a dry, lint-free cloth.

WARNING: DO NOT REMOVE OR INSTALL THE LOWER FILTER BY YOURSELF. It should be performed by an authorized dealer or a licensed service provider.

Store the unit when not in use

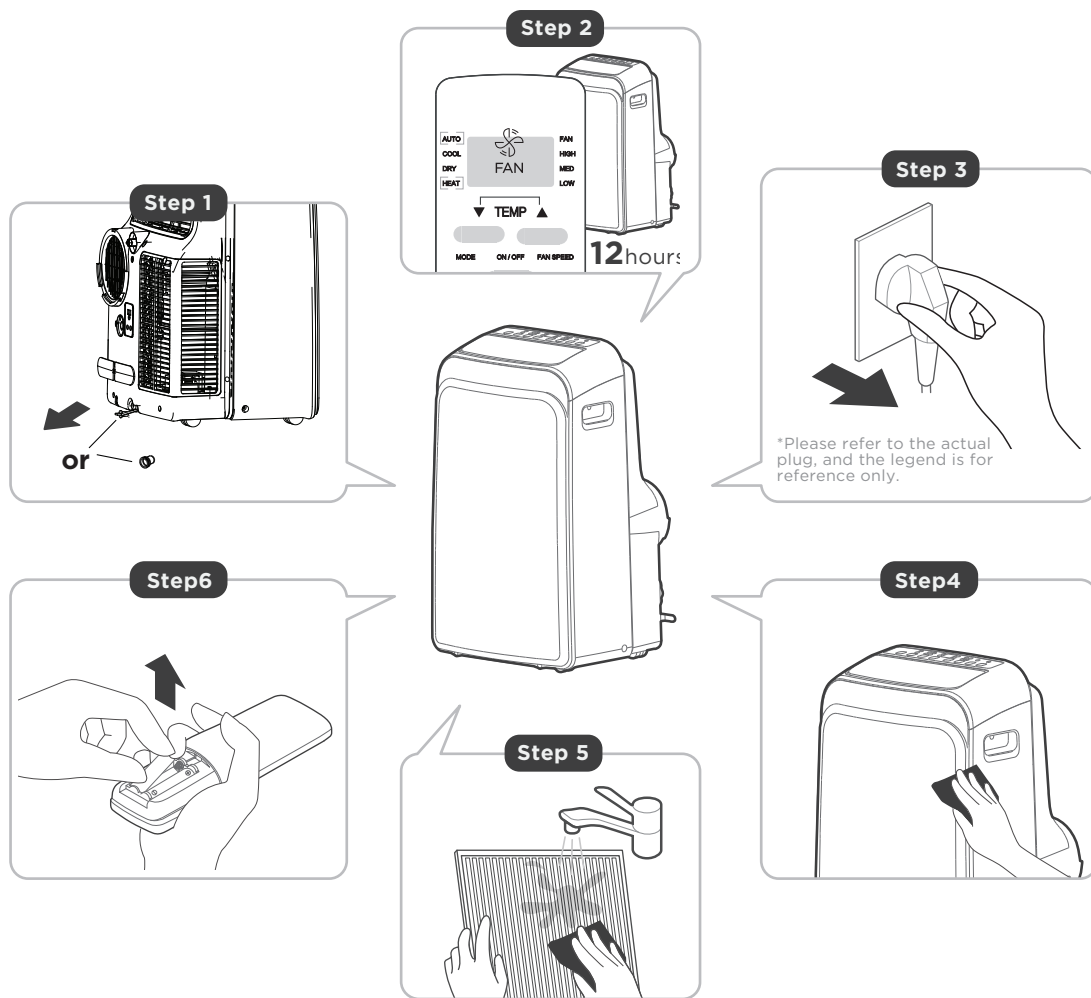

- Drain the unit's water collection tray according to the instructions in the following section.
- Run the appliance on FAN mode for 12 hours in a warm room to dry it and prevent mold.
- Turn off the appliance and unplug it.
- Clean the air filter according to the instructions in the previous section. Reinstall the clean, dry filter before storing.
- Remove the batteries from the remote control.

NOTE

Note: Be sure to store the unit in a cool, dark place. Exposure to direct sunshine or extreme heat can shorten the lifespan of the unit.

Note: The cabinet and front may be dusted with an oil-free cloth or washed with a cloth dampened in a solution of warm water and mild liquid dishwashing detergent. Rinse thoroughly and wipe dry. Never use harsh cleansers, wax or polish on the cabinet front. Be sure to wring excess water from the cloth before wiping around the controls. Excess water in or around the controls may cause damage to the unit.

TROUBLESHOOTING

Problem	Possible Causes	Solution
Unit does not turn on when pressing ON/OFF button	P1 Protection Code	The Water Collection Tray is full. Turn off the unit, drain the water from the Water Collection Tray and restart the unit.
	In COOL mode: room temperature is lower than the set temperature	Reset the temperature
Unit does not cool well	The air filter is blocked with dust or animal hair	Turn off the unit and clean the filter according to instructions
	Exhaust hose is not connected or is blocked	Turn off the unit, disconnect the hose, check for blockage and reconnect the hose
	The unit is low on refrigerant	Call a service technician to inspect the unit and top off refrigerant
	Temperature setting is too high	Decrease the set temperature
	The windows and doors in the room are open	Make sure all windows and doors are closed
	The room area is too large	Double-check the cooling area
	There are heat sources inside the room	Remove the heat sources if possible
The unit is noisy and vibrates too much	The ground is not level	Place the unit on a flat, level surface
	The air filter is blocked with dust or animal hair	Turn off the unit and clean the filter according to instructions
The unit makes a gurgling sound	This sound is caused by the flow of refrigerant inside the unit	This is normal

Impedance Information

To be in compliance EN 61000-3-11, the product MPPD-14CRN1-QB6 shall be connected only to a supply of the system impedance: $|Z_{sys}|=0.346$ ohms or less, the product MPPDB-12HRN1-QB6G1 shall be connected only to a supply of the system impedance: $|Z_{sys}|=0.337$ ohms or less. Before connect the product to public power network, please consult your local power supply authority to ensure the power network meet above requirement.

To be in compliance EN 61000-3-11, the product MPPDB-12HRN7-QB6G1 shall be connected only to a supply of the system impedance: $|Z_{sys}|=0.348$ ohms or less, the product MPPDB-12CRN7-QB6G1 shall be connected only to a supply of the system impedance: $|Z_{sys}|=0.362$ ohms or less. Before connect the product to public power network, please consult your local power supply authority to ensure the power network meet above requirement.

TRADEMARKS, COPYRIGHTS AND LEGAL STATEMENT

 Midea logo, word marks, trade name, trade dress and all versions thereof are valuable assets of Midea Group and/or its affiliates (“Midea”), to which Midea owns trademarks, copyrights and other intellectual property rights, and all goodwill derived from using any part of an Midea trademark. Use of Midea trademark for commercial purposes without the prior written consent of Midea may constitute trademark infringement or unfair competition in violation of relevant laws.

This manual is created by Midea and Midea reserves all copyrights thereof. No entity or individual may use, duplicate, modify, distribute in whole or in part this manual, or bundle or sell with other products without the prior written consent of Midea.

All the described functions and instructions were up to date at the time of printing this manual. However, the actual product may vary due to improved functions and designs.

DISPOSAL AND RECYCLING

Important instructions for environment(European Disposal Guidelines)

Compliance with the WEEE Directive and Disposing of the Waster Product:
This product complies with EU WEEE Directive. This product bears a classification symbol for waster electrical and electronic equipment (WEEE).

This symbol indicates that this product shall not be disposed with other household wastes at the end of its service life. Used device must be returned to official collection point for recycling of electrical electronic devices. To find these collection systems please contact to your local authorities or retailer where the product was purchased. Each household performs important role in recovering and recycling of old appliance. Appropriate disposal of used appliance helps prevent potential negative consequences for the environment and human health.

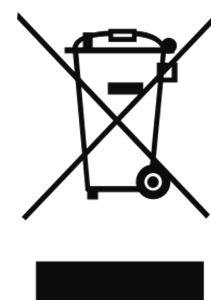

DATA PROTECTION NOTICE

For the provision of the services agreed with the customer, we agree to comply without restriction with all stipulations of applicable data protection law, in line with agreed countries within which services to the customer will be delivered, as well as, where applicable, the EU General Data Protection Regulation (GDPR).

Generally, our data processing is to fulfil our obligation under contract with you and for product safety reasons, to safeguard your rights in connection with warranty and product registration questions. In some cases, but only if appropriate data protection is ensured, personal data might be transferred to recipients located outside of the European Economic Area.

Further information are provided on request. You can contact our Data Protection Officer via **MideaDPO@midea.com**. To exercise your rights such as right to object your personal data being processed for direct marketing purposes, please contact us via **MideaDPO@midea.com**. To find further information, please follow the QR Code.

The design and specifications are subject to change without prior notice for product improvement. Consult with the sales agency or manufacturer for details. Any updates to the manual will be uploaded to the service website, please check for the latest version.

Importer: MIDEA AIR CONDITIONER AUSTRALIA

Manufacturer: GD Midea Air-Conditioning Equipment Co.,Ltd.
Lingang Road Beijiao Shunde Foshan Guangdong
People's Republic of China 528311



make yourself at home



<https://www.midea.com/au>
<https://www.mdhome.com.au>
© Midea 2022 all rights reserved

CP001UI-PDTY
16122000A78867
20230130