

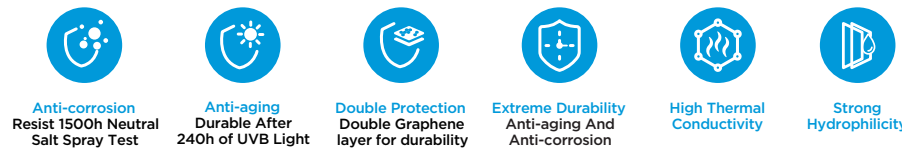

Built To Last



What Causes Corrosion in Air Conditioners?

The outdoor units are inevitably bitten by the external corrosion factors such as salt, acid and rain. Furthermore, the sunlight will accelerate the aging of the outdoor unit, even if it is not directly exposed to the sun, the heat exchanger will receive about 1/6 of the light radiation.

Corrosion on heat exchangers deteriorate the heat transfer performance, and the generated corrosive substances become obstacles to heat transfer, resulting in shortened product life.



Why Can Grapfins Enhance Corrosion Resistance?

Graphene is a single monolayer of carbon atoms, tightly bound in a hexagonal honeycomb lattice.

When graphene is added to the anti-corrosion layer, the density of the layer can be improved to resist corrosion.

5-Layer Structure, Double Protection

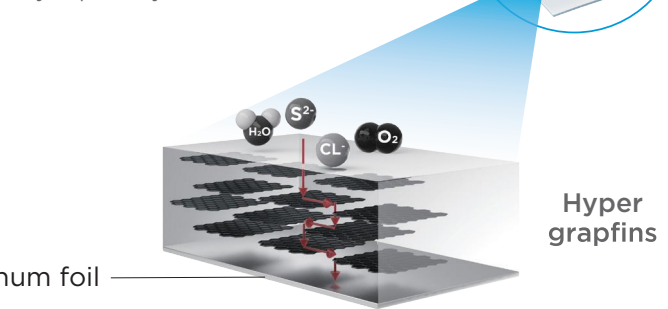

Extreme Durability

Verified by Two Test Standards

First Test Standard

Accelerated Corrosion Test

20 to 50-year¹ corrosion-resistance fin

Depended on the using industrial environment with salt contamination

Verified by **Intertek**

Second Test Standard

Midea Exclusive Anti-aging Technology Test

After 240 hours UV test and 72 hours neutral salt spray (fog) test

HYPER GRAPFINS

12.5X corrosion resistance than blue coating

Comparison Result of Corrosion Area



Hyper Grapfins **0.02%**²

Verified by **Intertek**

2. Midea exclusive anti-aging technology, Ref.test standard is QMK-J037.1021-2019 hydrophilic aluminum foil



Midea GAIA Specs



Market Model		MFCA26VA-N/ MFCA26VA-W	MFCA35VA-N/ MFCA35VA-W	MFCA50VA-N/ MFCA50VA-W	MFCA70VA-N/ MFCA70VA-W	
Power Supply	Ph-V-Hz	220-240V,1Ph,50Hz	220-240V,1Ph,50Hz	220-240V,1Ph,50Hz	220-240V,1Ph,50Hz	
Rated Cooling	Capacity	kW	2.60	3.55	5.20	7.00
	Min	kW	0.96	0.96	2.60	2.75
	Max	kW	3.00	3.80	7.00	7.30
	Input	W	520	800	1360	2060
	Rated Current	A	2.36	3.55	6.00	8.96
	EER	W/W	5.00	4.43	3.82	3.40
	Standby Power	W	1.4	1.4	1.4	1.4
	AEER	W/W	4.95	4.4	3.81	3.39
	Seasonal Star (Hot Zone)		7.0	5.5	4.5	4.0
	Seasonal Star (Mixed Zone)		6.0	5.5	4.0	3.5
Seasonal Star (Cold Zone)		6.5	5.5	4.5	4.0	
Rated Heating	Capacity	kW	2.65	3.60	5.20	8.05
	Min	kW	1.07	1.07	2.50	2.30
	Max	kW	2.90	3.90	7.00	8.29
	Input	W	500	770	1243	2250
	Rated Current	A	2.3	3.4	5.5	9.78
	COP	W/W	5.30	4.67	4.18	3.58
	Standby Power	W	1.4	1.4	1.4	1.4
	ACOP	W/W	5.25	4.6	4.16	3.57
	Seasonal Star (Hot Zone)		3.5	4.0	3.5	3.5
	Seasonal Star (Mixed Zone)		3.0	3.5	3.0	2.5
Seasonal Star (Cold Zone)		3.0	3.0	2.5	2.0	
Compressor	Type	ROTARY	ROTARY	ROTARY	ROTARY	
Indoor Noise Level (Sound Pressure Level) (Hi/Mi/Lo/Silence)	Indoor Noise Level	dB (A)	39.5/34.5/31/27	39.5/34.5/31/27	47/40/35.5/21	47/40/35.5/21
	Indoor Noise Level (Sound Power Level)	dB (A)	55	56	61	61
	Indoor Unit	Dimension (W*D*H)	mm	1000x212x335	1000x212x335	1088x336x239
Outdoor Unit	Packing (W*D*H)	mm	1095x415x315	1095x415x315	1185x415x355	1185x415x355
	Net/Gross Weight	Kg	13.4/18.2	13.4/18.2	16.2/20.8	16.2/20.8
	Outdoor Air Flow	m ³ /h	2200	2200	3500	3500
Outdoor Noise Level (Sound Pressure Level)	dB (A)	54	54	61	61	
Outdoor Noise Level (Sound Power Level)	dB (A)	56	59	66	68	
Outdoor Unit	Dimension (W*D*H)	mm	805x330x554	805x330x554	890x342x673	890x342x673
	Packing (W*D*H)	mm	915x370x615	915x370x615	1030x438x750	1030x438x750
	Net/Gross Weight	Kg	32.6/35.2	32.6/35.2	44.5/48.1	44.5/48.1
Refrigerant Piping	Liquid Side/ Gas Side	mm (inch)	6.35mm (1/4in)/ 9.52mm (3/8in)	6.35mm (1/4in)/ 9.52mm (3/8in)	6.35mm (1/4in)/ 12.7mm (1/2in)	6.35mm (1/4in)/ 12.7mm (1/2in)
	Room Temperature	Indoor (Cooling/Heating)	°C	16-32/0-30	16-32/0-30	16-32/0-30
Outdoor (Cooling/Heating)		°C	-15-50/-15-24	-15-50/-15-24	-15-50/-15-24	-15-50/-15-24
Refrigerant Type (Units Pre-charged for 15m Pipe Run)	Kg	R32/0.9	R32/0.9	R32/1.25	R32/1.25	
Max Current	A	11	11	17.5	17.5	



2.6kW
11~17m²

3.5kW
16~23m²

5.0kW
23~33m²

7.0kW
32~47m²



MDOO210526



Australia's Leading 7 Star Energy Rating



Partner of National Asthma Council Australia's Sensitive Choice Program



Australia's Longest 7-Year Warranty

Midea GAIA

The AC Inspired by Nature



Midea, established in 1968 is a public company listed and since July 2016 a Fortune 500 company offering one of the most comprehensive ranges in the home appliances industry. Midea specializes in air treatment (residential and commercial solutions), refrigeration, laundry, cooking appliances, small kitchen appliances, water appliances, floor care and lighting.

Simply ideal

(ideal product & ideal life)

Since 1968, Midea has been making homes more comfortable, efficient, and inspiring standing alongside millions of families around the world.

For over half a century, we have been part of everyday life, witnessing moments of joy, connection, and care in every corner of the home.

From pioneering smart technologies to creating

solutions that balance quality, innovation, and value, Midea has continuously redefined what the "ideal" home can be.

Our purpose has always been simple: to be by your side, making each day just right, and turning your home into a place where life feels simply ideal.

Founded in 2018, MD Appliances Pty Ltd is the official Australian distributor of Midea's air conditioning solutions for residential and commercial markets. Its mission is to deliver world-class cooling technology, energy efficiency, and superior comfort across Australia.

The company's vision is to become a leading HVAC company in the country, built on a professional team that combines experienced sales with agile operations and

after-sales support. With a long-term, efficiency-driven strategy and a culture of innovation, execution, and collaboration, MD Appliances has grown steadily since day one.

From deep on-site learning and capturing government energy rebates, to expanding contractor networks, opening brand stores, and scaling internal teams, MD Appliances has evolved into a mature and growing force in the Australian HVAC industry.

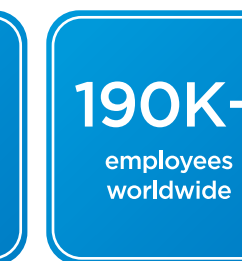
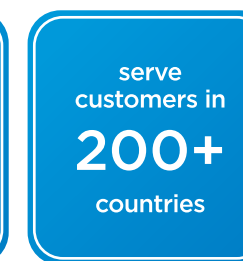

7 years parts and labor warranty

For Hi-Wall/ Ducted/ Cassette/ VRF / Heat pump



5 years parts and labor warranty

For Window Box A/C



2 years parts and labor warranty

For Heavy Commercial Products



Local after sales service and support

¹Source Euromonitor International (Shanghai) Limited; Consumer Appliances 25ed, retail volume sales in unit, 2024 data.

1. Ref. ISO 21207: 2015, Annex A, test method B

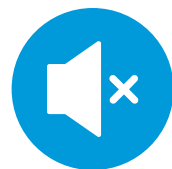

Quiet Operation

The noise level of GAIA in 3 modes

At high fan mode, GAIA is as low as 39.1 decibel, quieter than the library. At low fan mode, it is only 22.5 decibel. In silence mode, GAIA presents lower decibel level as 19.3.



40dB
Library



39.1dB
High Fan Mode



30dB
Forest at night



22.5dB
Low Fan Mode



20dB
Whisper

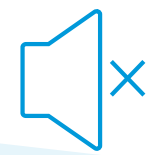

19.3dB
Silence Mode



ECO Function

As little as 2.2kWh per night (8 hours) in ECO mode.

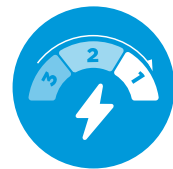

GEAR Function

Midea inverter air conditioners offer 3 operating power options: 50%, 75% and 100%. You can choose a lower power level to conserve energy.



Natural Wind Technology

TwinFlap™ with 7928 mini-holes and 3 adjustable Natural Wind modes, make airflow cool but comfortable.

TwinFlap™ with Mini-holes

The two opposite flaps can evolutionarily deflect, bent, and even spoil the airflow to be able to soften the harsh airflow, providing multiple levels of softness as you want without a noticeable breeze.

7928 Mini-holes

All 7928 micro-holes on the two deflectors are designed to soften to the cool air, where the cool air current passes through and transforms into thousands of unnoticeable tiny strings of air that Natural Wind drop the room temperature.

3 Adjustable Natural Wind Modes

Breeze Away Mode

Family Time
V≤0.5m/s | DR≤20

Wind Avoid Me Mode

Work Time
V≤0.3m/s | DR≤20

Natural Wind Mode

Undisturbed Sleep
V≤0.3m/s | DR≤5



Smart Choice for Sensitive Groups

-my true blue idea

The combination of Midea's refreshing air function, H13 HEPA filter application and 56°C sterilization functions have been rigorously reviewed and approved by the National Asthma Council Australia's Sensitive Choice Program.



O₂Fresh Air Exchange

Up to 30m³/h purified fresh air from outdoor, let staleness out & freshness in.

Hybrid Fresh Air Exchange System

Introduces the oxygen-rich air from the outside go inside, quickly renewing the indoor air with large air volume.

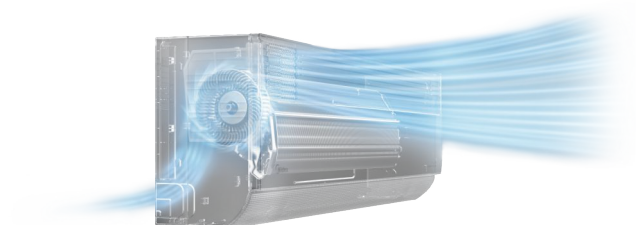

Micro-positive Pressure Technology

Keeps the indoor air pressure higher than the outdoor environment, which ensures stale air could be replaced.

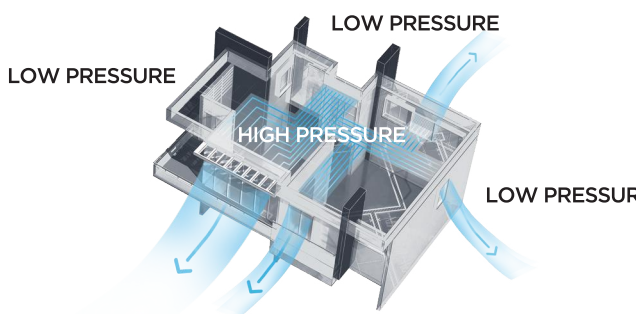

H13 HEPA Filter

Filtering efficiency as high as 99.99%, effectively filtering PM0.3 and other dust impurities and take care of healthy breathing.

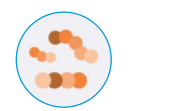

PM 0.3



Dead Mite Feces



Fungi



Flower Pollen



Pet Dander



Verified by **Intertek**
Total Quality Assured

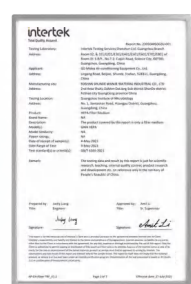

*Ref. test standard is GB/T 6165-2021. Test condition under 24.2, 51% relative humidity, 30m³/h air flow.



56°C Self-purification

6-step self-cleaning at up to 56 °C high temperature deeply purifies evaporator, providing you with fresh and clean air supply.

6 steps

92 mins

99.99% Sterilization

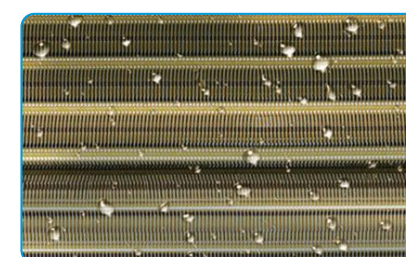

1 Water start to condensate, get ready for deep wash

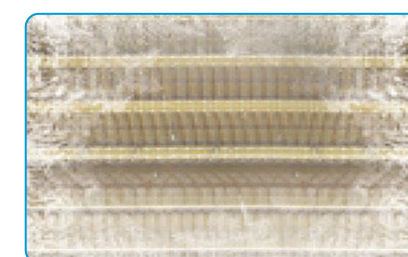

2 Condensated water gets frosting, removing dirt adhered to the evaporator

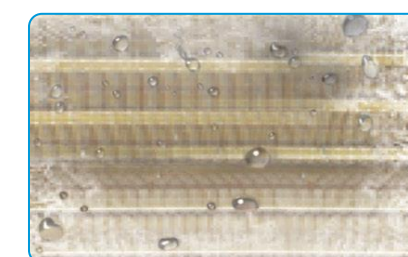

3 Defrost to form a large amount of water flow and peel off dirt

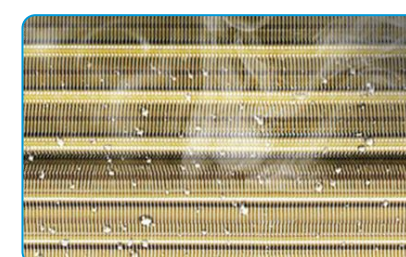

4 High temperature cleaning via steam, removing moisture and dust

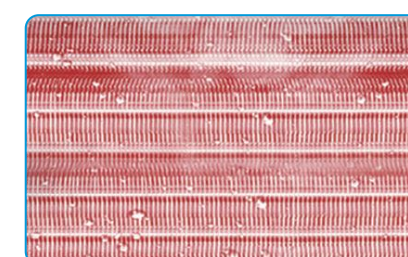

5 High temperature purification at up to 56°C

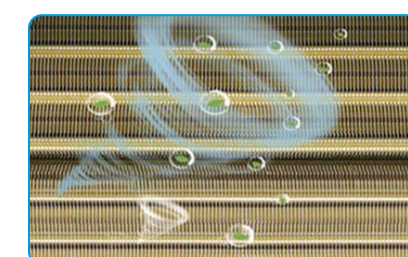

6 Fresh air supply

*Based on disinfection performance testing by UL (A802784), Midea GAIA unit removes escherichia coli, staphylococcus aureus, psudomonas ariginosa and klebsiella pneumoniae with the efficiency up to 99.99%.



Now Discover A Smarter Way

The Hidden Smart IoT Module Ensures

- Smart User-Experience
- Aesthetic Appearance



MSmartHome One APP, Total Control

Remote Control

- Power on/off
- Switch mode
- Control air direction and fan speed
- Control temperature and humidity

Data Monitor

- HEPA filter replacement reminder
- Temperature monitoring
- Humidity monitoring
- High temperature & humidity alert
- Weather display*1

Content Subscribe

- Tips on air health
- Brand news
- AC maintenance knowledge
- New arrival

